

# CONTENT

## 画册目录

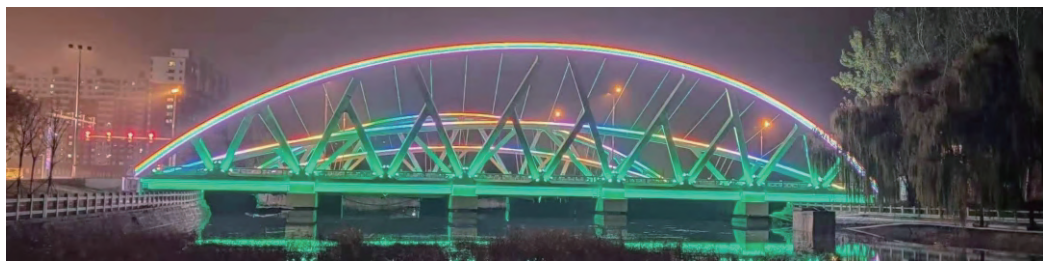

01	常规侧发光系列	Common Side Emitting	01-06
02	常规正发光系列	Common Front Emitting	07-13
03	180° /270° 发光系列	180° /270° Emitting	14
04	270° /360° 发光系列	180° /270° Emitting	15
05	360° 发光系列	360° Emitting	16-17
06	经济款系列	Economy Style Series	18-20
07	发光面罩系列	Surface Cover Series	21-23
08	透镜套管系列	Wall Washer Tubes	24-25
09	黑色套管系列	Black Tube Series	26-27
10	内置防断系列	Built-in Pet Sheet Tubes	28-29
11	常用单色套管系列	Common LED Strip Tubese	30-33
12	共挤加工系列	Co-extrusion Process Neon Strips	34-35
13	无边框液压堵头	Frameless Molding Caps	36
14	改性PVC套管系列	Modified PVC Tubes	37

## 常规侧发光系列

Common Side Emitting

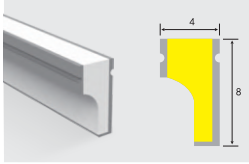

### YT0408胶条

出光方式 Emitting	侧发光 Side light
适合板宽 Strip width	5mm
产品重量 Weight	30g/m
产品材质 Material	高品质耐黄变纯硅胶 Food-class silicone
包装规格 Package	150米/卷 3卷/箱 150m/roll 3rolls/ctn

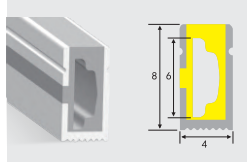

### YT0408侧发光

出光方式 Emitting	侧发光 Side light
适合板宽 Strip width	5mm
产品重量 Weight	30.2g/m
产品材质 Material	高品质耐黄变纯硅胶 Food-class silicone
包装规格 Package	150米/卷 3卷/箱 150m/roll 3rolls/ctn

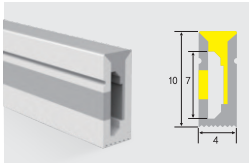
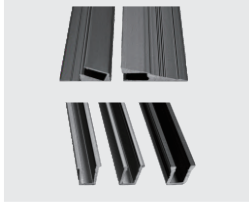

### YT0410

出光方式 Emitting	侧发光 Side light
适合板宽 Strip width	5/6mm
产品重量 Weight	38g/m
产品材质 Material	高品质耐黄变纯硅胶 Food-class silicone
包装规格 Package	100米/卷 4卷/箱 100m/roll 4rolls/ctn

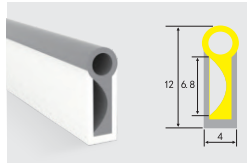

### YT0412

出光方式 Emitting	侧发光 Side light
适合板宽 Strip width	5mm
产品重量 Weight	40g/m
产品材质 Material	高品质耐黄变纯硅胶 Food-class silicone
包装规格 Package	100米/卷 4卷/箱 100m/roll 4rolls/ctn

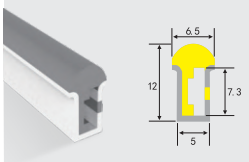
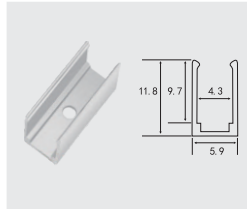
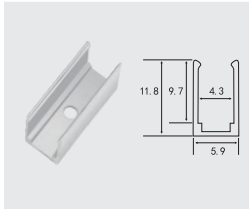

### YT0512

出光方式 Emitting	侧发光 Side light
适合板宽 Strip width	6mm
产品重量 Weight	65g/m
产品材质 Material	高品质耐黄变纯硅胶 Food-class silicone
包装规格 Package	100米/卷 2卷/箱 100m/roll 2rolls/ctn

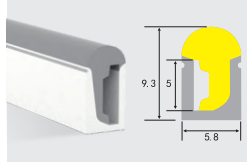

### YT0609

出光方式 Emitting	侧发光 Side light
适合板宽 Strip width	4mm
产品重量 Weight	45g/m
产品材质 Material	高品质耐黄变纯硅胶 Food-class silicone
包装规格 Package	200米/卷 2卷/箱 200m/roll 2rolls/ctn

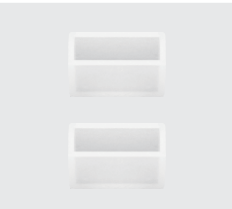
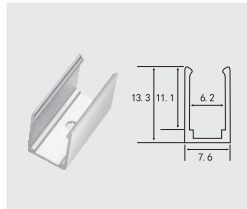
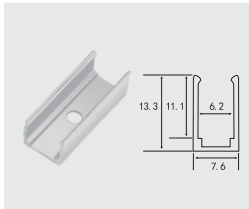

## 常规侧发光系列

Common Side Emitting

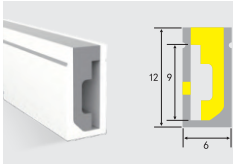

### YT0612

出光方式 Emitting	侧发光 Side light
适合板宽 Strip width	8mm
产品重量 Weight	75g/m
产品材质 Material	高品质耐黄变纯硅胶 Food-class silicone
包装规格 Package	100米/卷 2卷/箱 100m/roll 2rolls/ctn

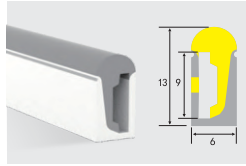

### YT0613

出光方式 Emitting	侧发光 Side light
适合板宽 Strip width	8mm
产品重量 Weight	75g/m
产品材质 Material	高品质耐黄变纯硅胶 Food-class silicone
包装规格 Package	100米/卷 2卷/箱 100m/roll 2rolls/ctn

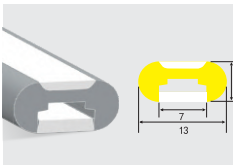
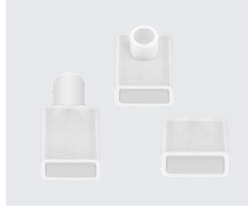
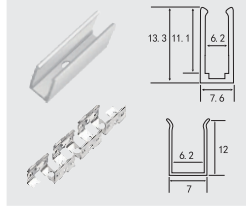
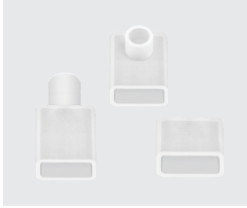
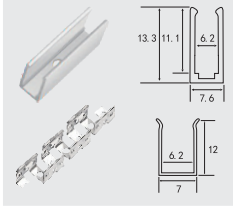

### YT0613双面发光

出光方式 Emitting	侧发光 Side light
适合板宽 Strip width	6mm
产品重量 Weight	75g/m
产品材质 Material	高品质耐黄变纯硅胶 Food-class silicone
包装规格 Package	100米/卷 2卷/箱 100m/roll 2rolls/ctn

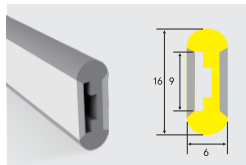

### YT0616双面发光

出光方式 Emitting	侧发光 Side light
适合板宽 Strip width	8mm
产品重量 Weight	90g/m
产品材质 Material	高品质耐黄变纯硅胶 Food-class silicone
包装规格 Package	100米/卷 2卷/箱 100m/roll 2rolls/ctn

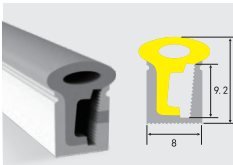

### YT0815蘑菇头

出光方式 Emitting	侧发光 Side light
适合板宽 Strip width	8mm
产品重量 Weight	114g/m
产品材质 Material	高品质耐黄变纯硅胶 Food-class silicone
包装规格 Package	100米/卷 2卷/箱 100m/roll 2rolls/ctn

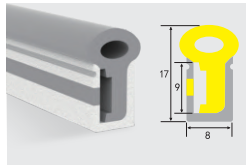

### YT0817

出光方式 Emitting	侧发光 Side light
适合板宽 Strip width	8mm
产品重量 Weight	145g/m
产品材质 Material	高品质耐黄变纯硅胶 Food-class silicone
包装规格 Package	100米/卷 2卷/箱 100m/roll 2rolls/ctn

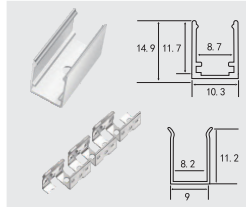
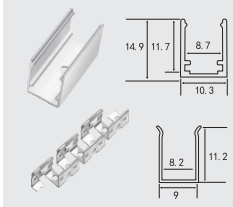

## 常规侧发光系列 Common Side Emitting

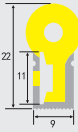
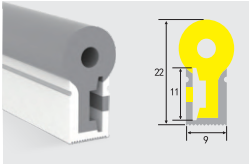

### YT0922

出光方式 Emitting	侧发光 Side light
适合板宽 Strip width	10mm
产品重量 Weight	210g/m
产品材质 Material	高品质耐黄变纯硅胶 Food-class silicone
包装规格 Package	50米/卷 2卷/箱 50m/roll 2rolls/ctn

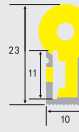
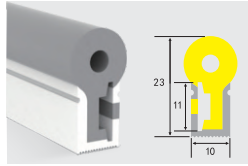
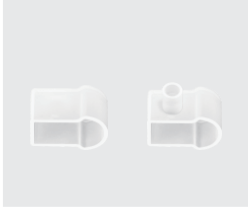
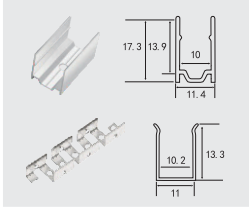

### YT1023

出光方式 Emitting	侧发光 Side light
适合板宽 Strip width	10mm
产品重量 Weight	220g/m
产品材质 Material	高品质耐黄变纯硅胶 Food-class silicone
包装规格 Package	50米/卷 2卷/箱 50m/roll 2rolls/ctn

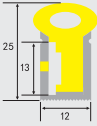
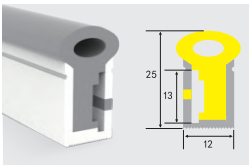
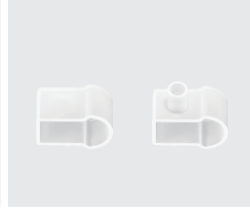
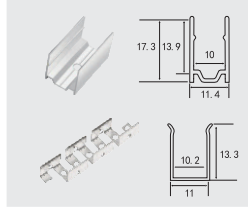

### YT1225

出光方式 Emitting	侧发光 Side light
适合板宽 Strip width	12mm
产品重量 Weight	285g/m
产品材质 Material	高品质耐黄变纯硅胶 Food-class silicone
包装规格 Package	50米/卷 2卷/箱 50m/roll 2rolls/ctn

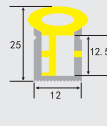
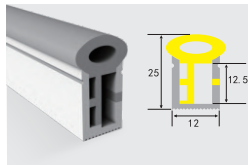
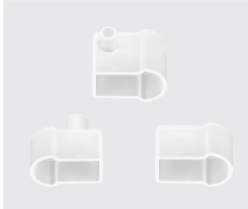
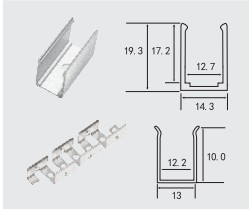

### YT1225大内空

出光方式 Emitting	侧发光 Side light
适合板宽 Strip width	12mm
产品重量 Weight	305g/m
产品材质 Material	高品质耐黄变纯硅胶 Food-class silicone
包装规格 Package	50米/卷 2卷/箱 50m/roll 2rolls/ctn

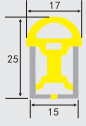
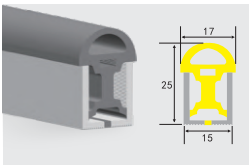
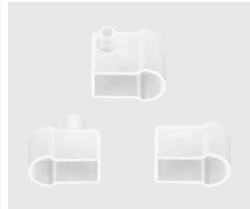
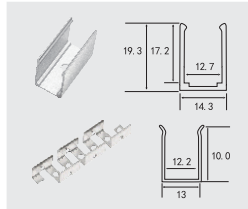

### YT1525三板

出光方式 Emitting	侧发光 Side light
适合板宽 Strip width	10mm
产品重量 Weight	290g/m
产品材质 Material	高品质耐黄变纯硅胶 Food-class silicone
包装规格 Package	50米/卷 2卷/箱 100m/roll 2rolls/ctn

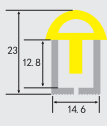
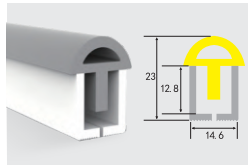
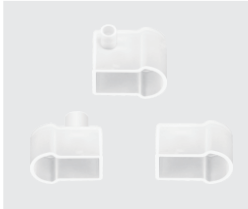
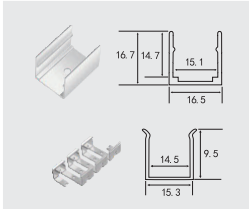

### YT1523 底开口

出光方式 Emitting	侧发光 Side light
适合板宽 Strip width	10/12mm
产品重量 Weight	280g/m
产品材质 Material	高品质耐黄变纯硅胶 Food-class silicone
包装规格 Package	50米/卷 2卷/箱 50m/roll 2rolls/ctn

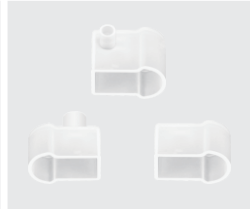
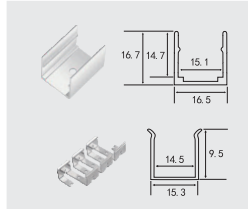

## 常规侧发光系列 Common Side Emitting

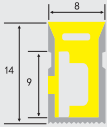
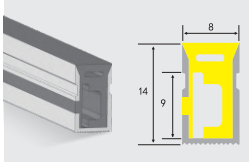

### YT0814平头

出光方式 Emitting	侧发光 Side light
适合板宽 Strip width	8mm
产品重量 Weight	145g/m
产品材质 Material	高品质耐黄变纯硅胶 Food-class silicone
包装规格 Package	50米/卷 2卷/箱 50m/roll 2rolls/ctn

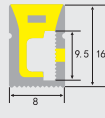
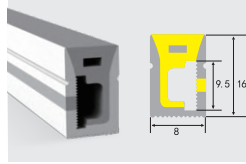
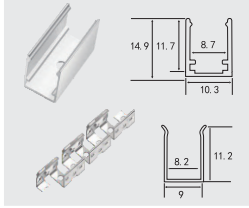

### YT0816平头

出光方式 Emitting	侧发光 Side light
适合板宽 Strip width	8mm
产品重量 Weight	118g/m
产品材质 Material	高品质耐黄变纯硅胶 Food-class silicone
包装规格 Package	50米/卷 2卷/箱 50m/roll 2rolls/ctn

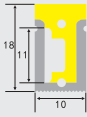
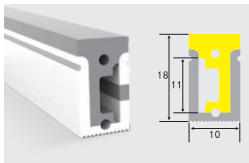
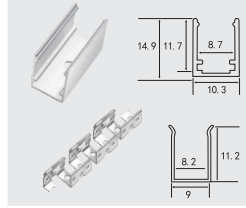

### YT1018

出光方式 Emitting	侧发光 Side light
适合板宽 Strip width	10mm
产品重量 Weight	170g/m
产品材质 Material	高品质耐黄变纯硅胶 Food-class silicone
包装规格 Package	50米/卷 2卷/箱 50m/roll 2rolls/ctn

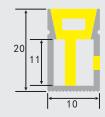
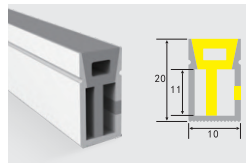
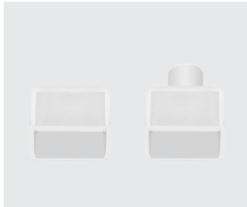
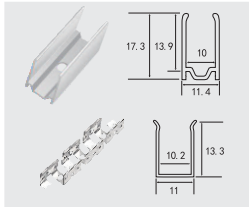

### YT1020

出光方式 Emitting	侧发光 Side light
适合板宽 Strip width	10mm
产品重量 Weight	165g/m
产品材质 Material	高品质耐黄变纯硅胶 Food-class silicone
包装规格 Package	50米/卷 2卷/箱 50m/roll 2rolls/ctn

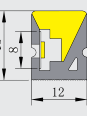
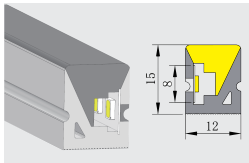
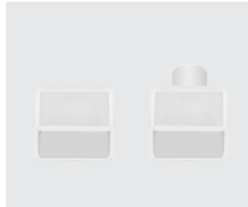
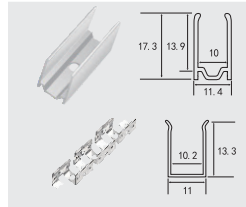

### YT1215单面

出光方式 Emitting	侧发光 Side light
适合板宽 Strip width	8mm
产品重量 Weight	180g/m
产品材质 Material	高品质耐黄变纯硅胶 Food-class silicone
包装规格 Package	50米/卷 2卷/箱 50m/roll 2rolls/ctn

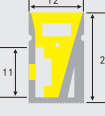
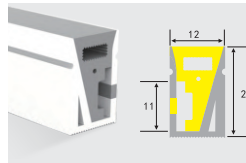
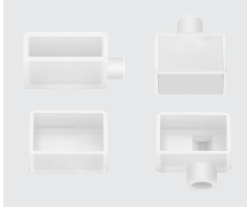
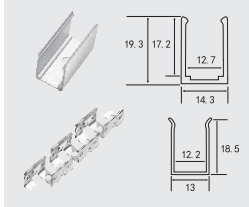

### YT1220单面

出光方式 Emitting	侧发光 Side light
适合板宽 Strip width	10mm
产品重量 Weight	225g/m
产品材质 Material	高品质耐黄变纯硅胶 Food-class silicone
包装规格 Package	50米/卷 2卷/箱 50m/roll 2rolls/ctn

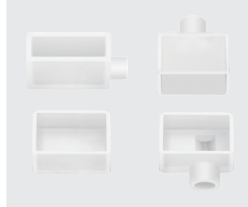
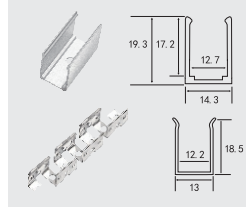

## 常规侧发光系列 Common Side Emitting

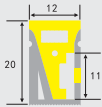
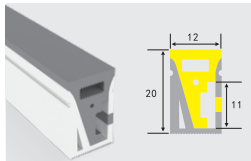

### YT1220三面

出光方式 Emitting	侧发光 Side light
适合板宽 Strip width	10mm
产品重量 Weight	225g/m
产品材质 Material	高品质耐黄变纯硅胶 Food-class silicone
包装规格 Package	50米/卷 50m/roll

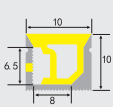
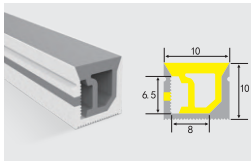
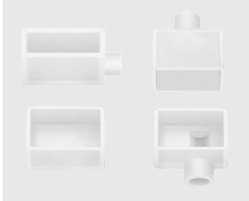
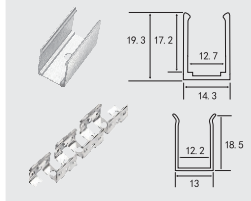

### YT1010侧发光

出光方式 Emitting	侧发光 Side light
适合板宽 Strip width	5mm
产品重量 Weight	88g/m
产品材质 Material	高品质耐黄变纯硅胶 Food-class silicone
包装规格 Package	100米/卷 2卷/箱 100m/roll 2rolls/ctn

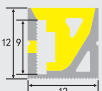
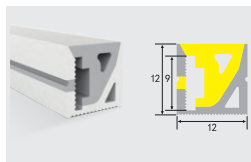
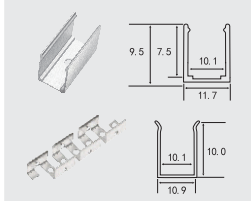

### YT1212侧发光

出光方式 Emitting	侧发光 Side light
适合板宽 Strip width	8mm
产品重量 Weight	135g/m
产品材质 Material	高品质耐黄变纯硅胶 Food-class silicone
包装规格 Package	100米/卷 2卷/箱 100m/roll 2rolls/ctn

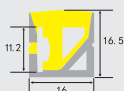
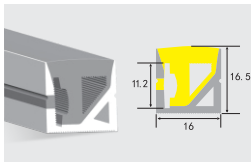
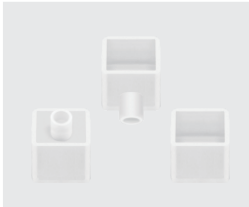
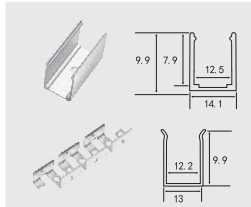

### YT1616侧发光

出光方式 Emitting	侧发光 Side light
适合板宽 Strip width	10mm
产品重量 Weight	220g/m
产品材质 Material	高品质耐黄变纯硅胶 Food-class silicone
包装规格 Package	50米/卷 2卷/箱 50m/roll 2rolls/ctn

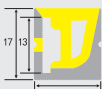
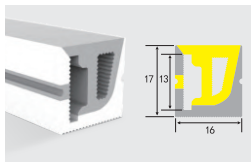
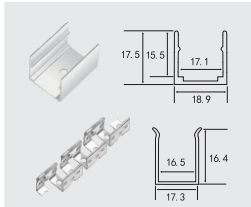

### YT1617

出光方式 Emitting	侧发光 Side light
适合板宽 Strip width	12mm
产品重量 Weight	232g/m
产品材质 Material	高品质耐黄变纯硅胶 Food-class silicone
包装规格 Package	50米/卷 2卷/箱 50m/roll 2rolls/ctn

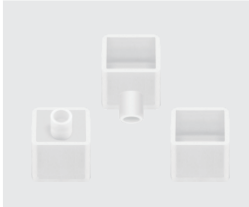
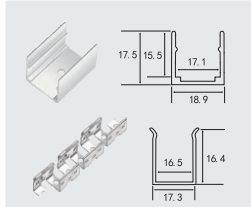

## 常规侧发光系列 Common Side Emitting

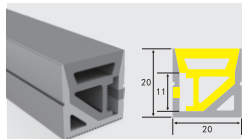

### YT2020侧发光

出光方式 Emitting	侧发光 Side light
适合板宽 Strip width	10mm
产品重量 Weight	310g/m
产品材质 Material	高品质耐黄变纯硅胶 Food-class silicone
包装规格 Package	50米/卷 2卷/箱 50m/roll 2rolls/ctn

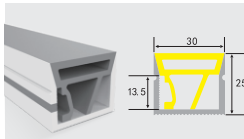

### YT3025侧发光

出光方式 Emitting	侧发光 Side light
适合板宽 Strip width	12mm
产品重量 Weight	510g/m
产品材质 Material	高品质耐黄变纯硅胶 Food-class silicone
包装规格 Package	50米/箱 50m/roll

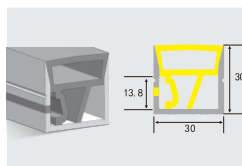
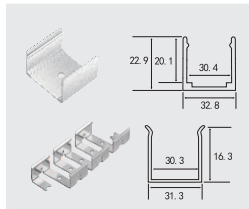
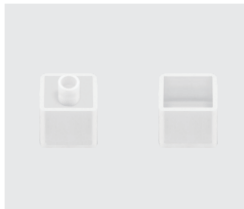
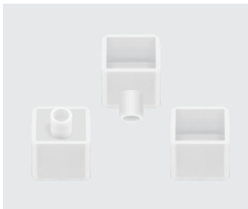
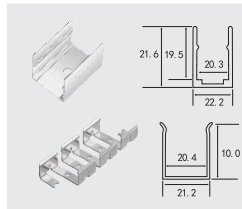

### YT3030

出光方式 Emitting	侧发光 Side light
适合板宽 Strip width	12mm
产品重量 Weight	485g/m
产品材质 Material	高品质耐黄变纯硅胶 Food-class silicone
包装规格 Package	30米/箱 30m/roll

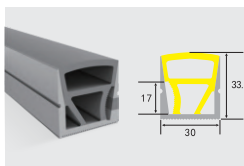

### YT3032

出光方式 Emitting	侧发光 Side light
适合板宽 Strip width	15mm
产品重量 Weight	610g/m
产品材质 Material	高品质耐黄变纯硅胶 Food-class silicone
包装规格 Package	30米/箱 30m/roll

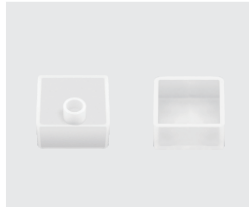
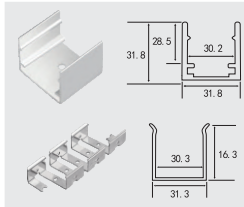
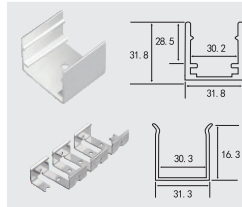

点亮效果

## 常规正发光系列

Common Front Emitting

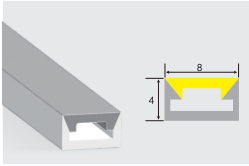

### YT0408

出光方式 Emitting	正发光 Front light
适合板宽 Strip width	6mm
产品重量 Weight	30.2g/m
产品材质 Material	高品质耐黄变纯硅胶 Food-class silicone
包装规格 Package	200米/卷 2卷/箱 200m/roll 2rolls/ctn

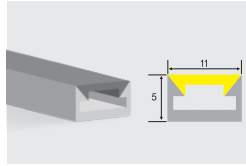

### YT0511

出光方式 Emitting	正发光 Front light
适合板宽 Strip width	8mm
产品重量 Weight	47g/m
产品材质 Material	高品质耐黄变纯硅胶 Food-class silicone
包装规格 Package	200米/卷 2卷/箱 200m/roll 2rolls/ctn

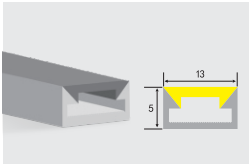
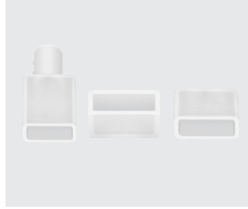
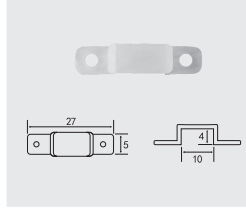
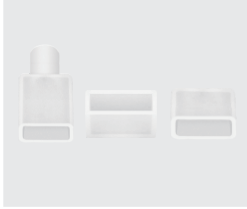
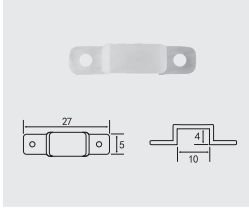

### YT0513

出光方式 Emitting	正发光 Front light
适合板宽 Strip width	10mm
产品重量 Weight	50g/m
产品材质 Material	高品质耐黄变纯硅胶 Food-class silicone
包装规格 Package	200米/卷 2卷/箱 200m/roll 2rolls/ctn

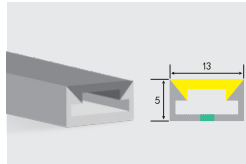

### YT0513三色

出光方式 Emitting	正发光 Front light
适合板宽 Strip width	10mm
产品重量 Weight	50g/m
产品材质 Material	高品质耐黄变纯硅胶 Food-class silicone
包装规格 Package	200米/卷 2卷/箱 200m/roll 2rolls/ctn

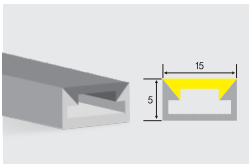
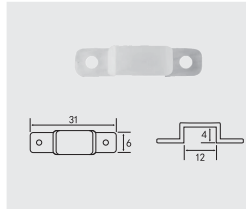
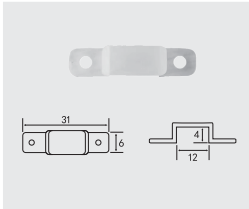

### YT0515

出光方式 Emitting	正发光 Front light
适合板宽 Strip width	12mm
产品重量 Weight	65g/m
产品材质 Material	高品质耐黄变纯硅胶 Food-class silicone
包装规格 Package	150米/卷 2卷/箱 150m/roll 2rolls/ctn

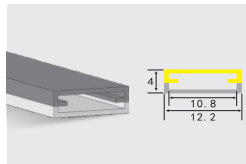

### YT10宽带卡双色套管

颜色 Color	透明 Transparent
适合板宽 Strip width	10mm
产品重量 Weight	36g/m
产品材质 Material	高品质耐黄变纯硅胶 Food-class silicone
包装规格 Package	250米/卷 4卷/箱 250m/roll 4rolls/ctn

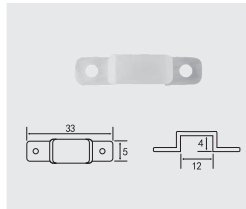
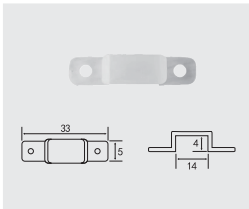



## 常规正发光系列 Common Front Emitting

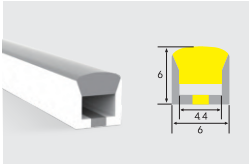

### YT0606

出光方式 Emitting	正发光 Front light
适合板宽 Strip width	3mm
产品重量 Weight	37g/m
产品材质 Material	高品质耐黄变纯硅胶 Food-class silicone
包装规格 Package	100米/卷 2卷/箱 100m/roll 2rolls/ctn

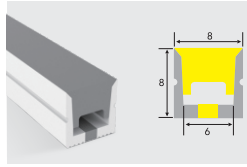

### YT0808

出光方式 Emitting	正发光 Front light
适合板宽 Strip width	5mm
产品重量 Weight	56g/m
产品材质 Material	高品质耐黄变纯硅胶 Food-class silicone
包装规格 Package	100米/卷 2卷/箱 100m/roll 2rolls/ctn

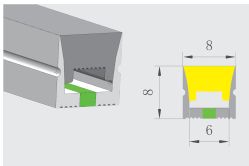
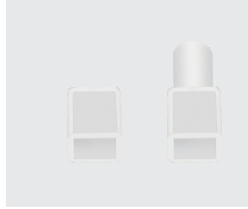
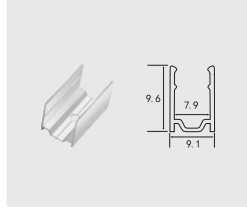
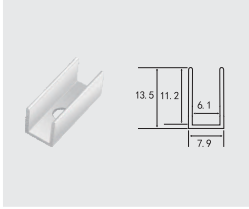

### YT0808三色

出光方式 Emitting	正发光 Front light
适合板宽 Strip width	5mm
产品重量 Weight	56g/m
产品材质 Material	高品质耐黄变纯硅胶 Food-class silicone
包装规格 Package	100米/卷 2卷/箱 100m/roll 2rolls/ctn

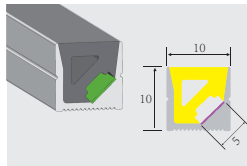

### YT1010 3D

出光方式 Emitting	正侧发光 Front light
适合板宽 Strip width	4mm
产品重量 Weight	100g/m
产品材质 Material	高品质耐黄变纯硅胶 Food-class silicone
包装规格 Package	100米/卷 2卷/箱 100m/roll 2rolls/ctn

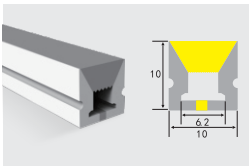
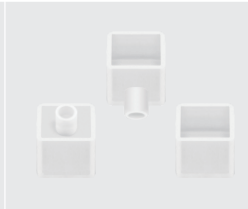
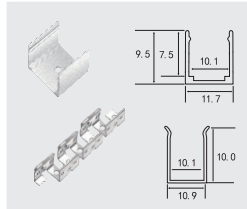
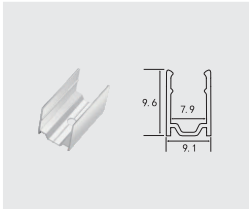

### YT1010A单面

出光方式 Emitting	正发光 Front light
适合板宽 Strip width	5mm
产品重量 Weight	100g/m
产品材质 Material	高品质耐黄变纯硅胶 Food-class silicone
包装规格 Package	100米/卷 2卷/箱 100m/roll 2rolls/ctn

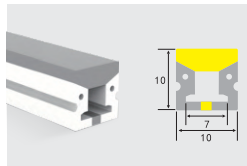

### YT1010A小三面

出光方式 Emitting	正发光 Front light
适合板宽 Strip width	5/6mm
产品重量 Weight	100g/m
产品材质 Material	高品质耐黄变纯硅胶 Food-class silicone
包装规格 Package	100米/卷 2卷/箱 100m/roll 2rolls/ctn

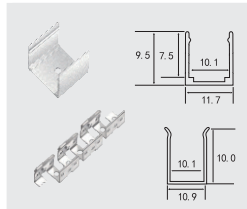
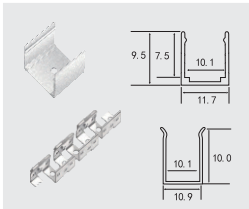

## 常规正发光系列 Common Front Emitting

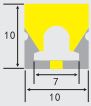
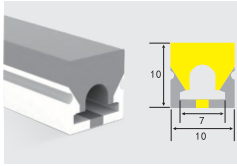

### YT1010B 大三面

出光方式 Emitting	正发光 Front light
适合板宽 Strip width	5/6mm
产品重量 Weight	100g/m
产品材质 Material	高品质耐黄变纯硅胶 Food-class silicone
包装规格 Package	100米/卷 2卷/箱 100m/roll 2rolls/ctn

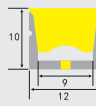
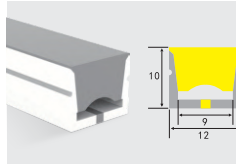

### YT1210

出光方式 Emitting	正发光 Front light
适合板宽 Strip width	8mm
产品重量 Weight	120g/m
产品材质 Material	高品质耐黄变纯硅胶 Food-class silicone
包装规格 Package	100米/卷 2卷/箱 100m/roll 2rolls/ctn

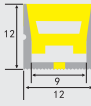
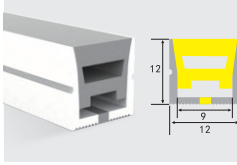
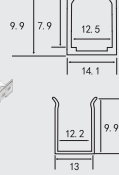
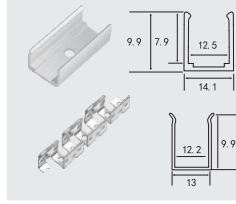
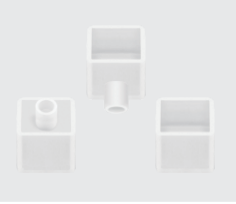
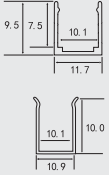
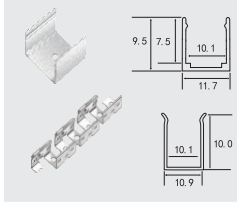

### YT1212单面

出光方式 Emitting	正发光 Front light
适合板宽 Strip width	8mm
产品重量 Weight	135g/m
产品材质 Material	高品质耐黄变纯硅胶 Food-class silicone
包装规格 Package	100米/卷 2卷/箱 100m/roll 2rolls/ctn

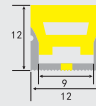
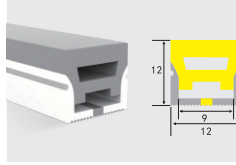

### YT1212 三面

出光方式 Emitting	正发光 Front light
适合板宽 Strip width	8mm
产品重量 Weight	135g/m
产品材质 Material	高品质耐黄变纯硅胶 Food-class silicone
包装规格 Package	100米/卷 2卷/箱 100m/roll 2rolls/ctn

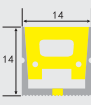
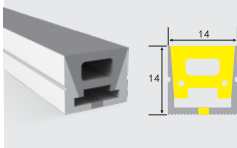
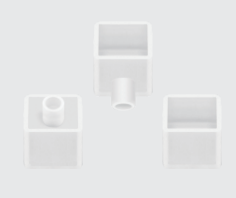
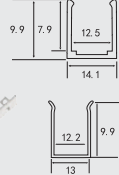
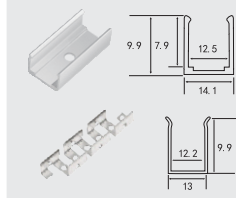
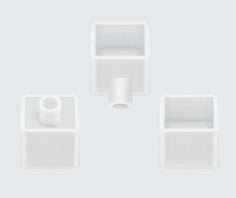
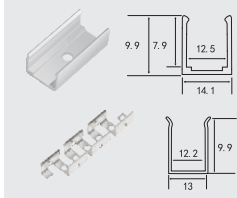

### YT1414 单面

出光方式 Emitting	正发光 Front light
适合板宽 Strip width	10mm
产品重量 Weight	170g/m
产品材质 Material	高品质耐黄变纯硅胶 Food-class silicone
包装规格 Package	50米/卷 2卷/箱 50m/roll 2rolls/ctn

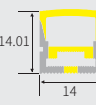
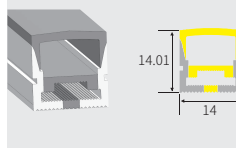

### YT1414 三面

出光方式 Emitting	正发光 Front light
适合板宽 Strip width	10mm
产品重量 Weight	140g/m
产品材质 Material	高品质耐黄变纯硅胶 Food-class silicone
包装规格 Package	50米/卷 2卷/箱 50m/roll 2rolls/ctn

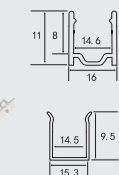
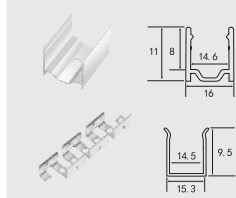
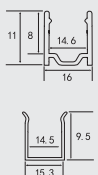
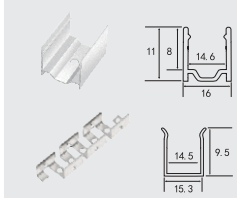

## 常规正发光系列

Common Front Emitting

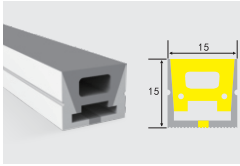

### YT1515 单面

出光方式 Emitting	正发光 Front Light
适合板宽 Strip width	10mm
产品重量 Weight	170g/m
产品材质 Material	高品质耐黄变纯硅胶 Food-class silicone
包装规格 Package	50米/卷 2卷/箱 50m/roll 2rolls/ctn

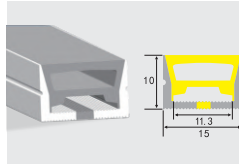

### YT1510 单面

出光方式 Emitting	正发光 Front Light
适合板宽 Strip width	10mm
产品重量 Weight	128g/m
产品材质 Material	高品质耐黄变纯硅胶 Food-class silicone
包装规格 Package	50米/卷 2卷/箱 50m/roll 2rolls/ctn

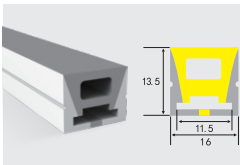
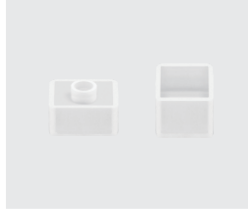
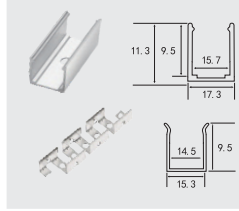
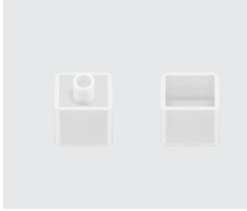
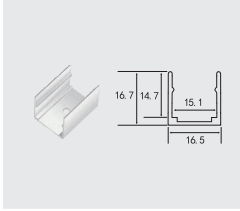

### YT1614单面

出光方式 Emitting	正发光 Front Light
适合板宽 Strip width	10mm
产品重量 Weight	210g/m
产品材质 Material	高品质耐黄变纯硅胶 Food-class silicone
包装规格 Package	50米/卷 2卷/箱 50m/roll 2rolls/ctn

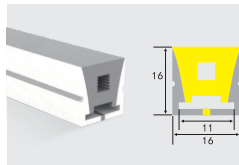

### YT1616

出光方式 Emitting	正发光 Front Light
适合板宽 Strip width	10/12mm
产品重量 Weight	240g/m
产品材质 Material	高品质耐黄变纯硅胶 Food-class silicone
包装规格 Package	50米/卷 2卷/箱 50m/roll 2rolls/ctn

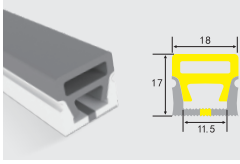
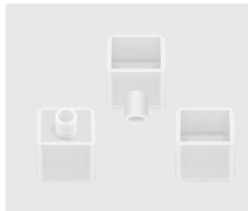
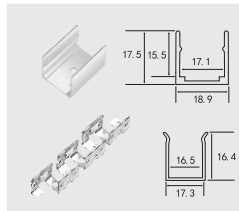
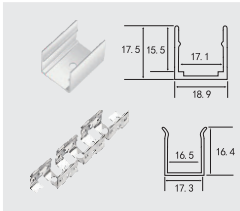

### YT1817

出光方式 Emitting	正发光 Front Light
适合板宽 Strip width	10mm
产品重量 Weight	240g/m
产品材质 Material	高品质耐黄变纯硅胶 Food-class silicone
包装规格 Package	50米/卷 2卷/箱 50m/roll 2rolls/ctn

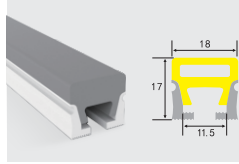

### YT1817底开口

出光方式 Emitting	正发光 Front Light
适合板宽 Strip width	10mm
产品重量 Weight	240g/m
产品材质 Material	高品质耐黄变纯硅胶 Food-class silicone
包装规格 Package	50米/卷 2卷/箱 50m/roll 2rolls/ctn

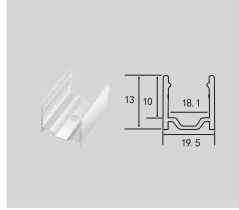
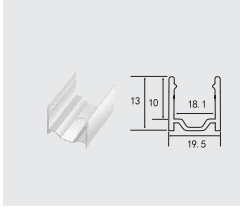

## 常规正发光系列 Common Front Emitting

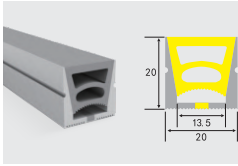

### YT2020

出光方式 Emitting	正发光 Front Light
适合板宽 Strip width	12mm
产品重量 Weight	330g/m
产品材质 Material	高品质耐黄变纯硅胶 Food-class silicone
包装规格 Package	50米/卷 2卷/箱 50m/roll 2rolls/ctn

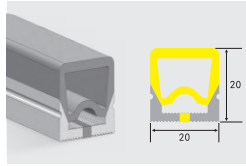

### YT2020-3面

出光方式 Emitting	正发光 Front Light
适合板宽 Strip width	12mm
产品重量 Weight	258g/m
产品材质 Material	高品质耐黄变纯硅胶 Food-class silicone
包装规格 Package	50米/卷 2卷/箱 50m/roll 2rolls/ctn

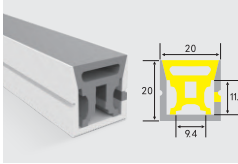
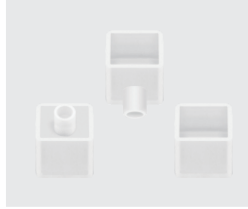
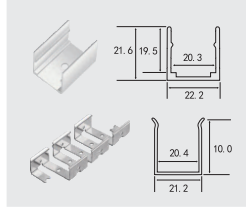
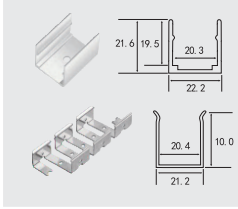

### YT2020-3板

出光方式 Emitting	正发光 Front Light
适合板宽 Strip width	8/10mm
产品重量 Weight	330g/m
产品材质 Material	高品质耐黄变纯硅胶 Food-class silicone
包装规格 Package	50米/卷 2卷/箱 50m/roll 2rolls/ctn

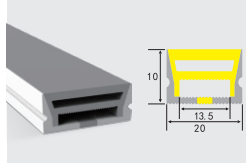

### YT2010单面

出光方式 Emitting	正发光 Front Light
适合板宽 Strip width	10mm
产品重量 Weight	170g/m
产品材质 Material	高品质耐黄变纯硅胶 Food-class silicone
包装规格 Package	50米/卷 2卷/箱 50m/roll 2rolls/ctn

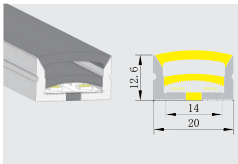
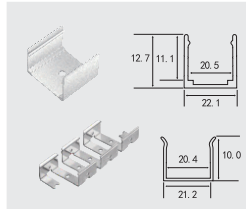
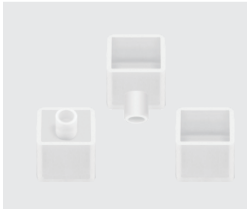
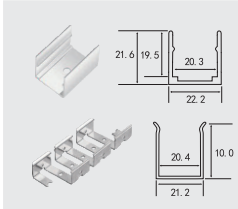

### YT2012单面

出光方式 Emitting	正发光 Front Light
适合板宽 Strip width	10mm
产品重量 Weight	200g/m
产品材质 Material	高品质耐黄变纯硅胶 Food-class silicone
包装规格 Package	50米/卷 2卷/箱 50m/roll 2rolls/ctn

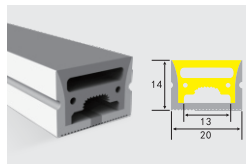

### YT2014单面

出光方式 Emitting	正发光 Front Light
适合板宽 Strip width	12mm
产品重量 Weight	240g/m
产品材质 Material	高品质耐黄变纯硅胶 Food-class silicone
包装规格 Package	50米/卷 2卷/箱 50m/roll 2rolls/ctn

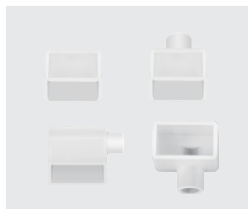
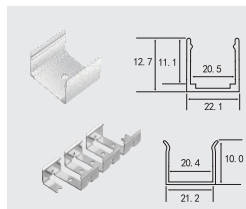
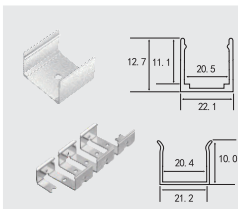

## 常规正发光系列 Common Front Emitting

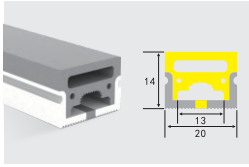

### YT2014三面

出光方式 Emitting	正发光 Front Light
适合板宽 Strip width	12mm
产品重量 Weight	240g/m
产品材质 Material	高品质耐黄变纯硅胶 Food-class silicone
包装规格 Package	50米/卷 2卷/箱 50m/roll 2rolls/ctn

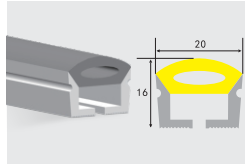

### YT2016弧面

出光方式 Emitting	正发光 Front Light
适合板宽 Strip width	10mm
产品重量 Weight	234g/m
产品材质 Material	高品质耐黄变纯硅胶 Food-class silicone
包装规格 Package	50米/卷 2卷/箱 50m/roll 2rolls/ctn

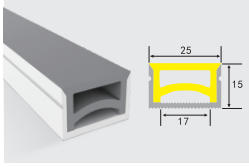
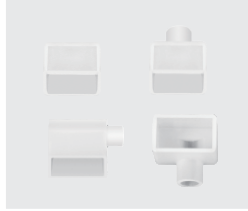
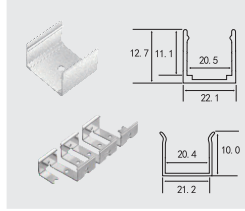
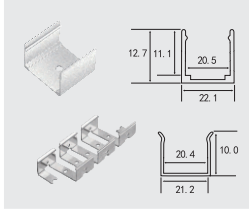

### YT2515

出光方式 Emitting	正发光 Front Light
适合板宽 Strip width	15mm
产品重量 Weight	320g/m
产品材质 Material	高品质耐黄变纯硅胶 Food-class silicone
包装规格 Package	50米/卷 2卷/箱 50m/roll 2rolls/ctn

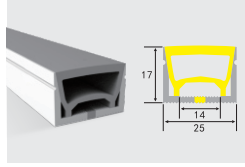

### YT2517

出光方式 Emitting	正发光 Front Light
适合板宽 Strip width	12mm
产品重量 Weight	290g/m
产品材质 Material	高品质耐黄变纯硅胶 Food-class silicone
包装规格 Package	50米/卷 2卷/箱 50m/roll 2rolls/ctn

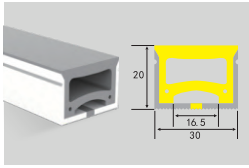
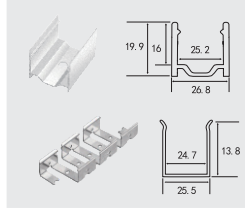
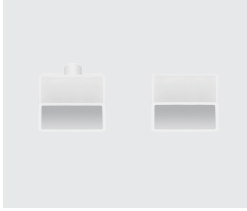
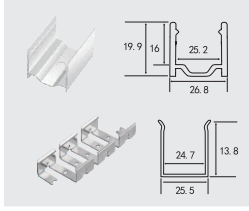

### YT3020

出光方式 Emitting	正发光 Front Light
适合板宽 Strip width	15mm
产品重量 Weight	480g/m
产品材质 Material	高品质耐黄变纯硅胶 Food-class silicone
包装规格 Package	50米/箱 50m/roll

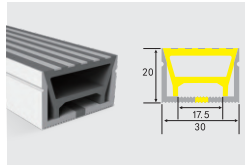

### YT3020条纹

出光方式 Emitting	正发光 Front Light
适合板宽 Strip width	15mm
产品重量 Weight	385g/m
产品材质 Material	高品质耐黄变纯硅胶 Food-class silicone
包装规格 Package	50米/箱 50m/roll

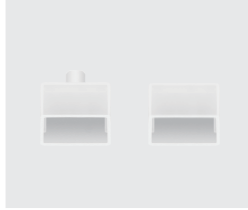
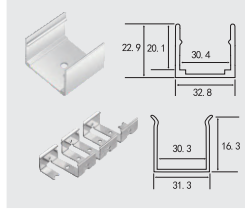
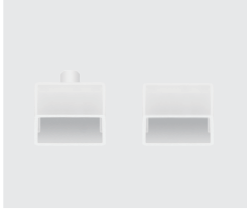
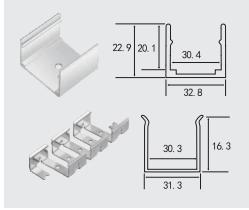

## 常规正发光系列 Common Front Emitting

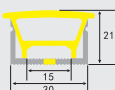
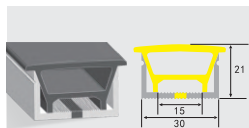

### YT3020有底带边

出光方式 Emitting	正发光 Front light
适合板宽 Strip width	15mm
产品重量 Weight	480g/m
产品材质 Material	高品质耐黄变纯硅胶 Food-class silicone
包装规格 Package	50米/箱 50m/roll

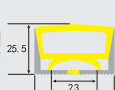
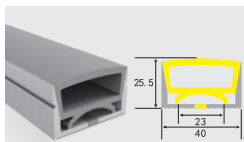
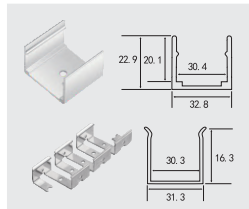

### YT4025

出光方式 Emitting	正发光 Front light
适合板宽 Strip width	20mm
产品重量 Weight	700g/m
产品材质 Material	高品质耐黄变纯硅胶 Food-class silicone
包装规格 Package	30米/箱 30m/ctn

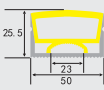
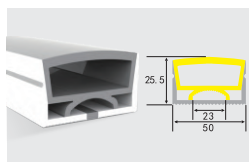
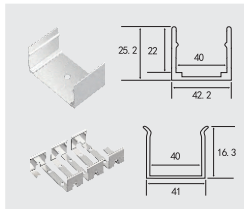

### YT5025

出光方式 Emitting	正发光 Front light
适合板宽 Strip width	20mm
产品重量 Weight	780g/m
产品材质 Material	高品质耐黄变纯硅胶 Food-class silicone
包装规格 Package	30米/箱 30m/ctn

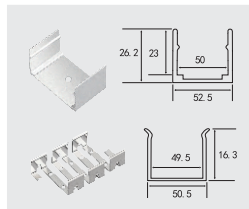

## 180° / 270° 发光系列

### 180° / 270° Emitting

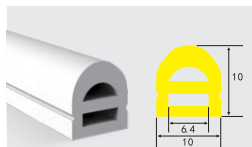

#### YT1010半圆

出光方式 Emitting	半圆/180° 出光 180° glow on sides
适合板宽 Strip width	5mm
产品重量 Weight	92g/m
产品材质 Material	高品质耐黄变纯硅胶 Food-class silicone
包装规格 Package	100米/卷 2卷/箱 100m/roll 2rolls/ctn

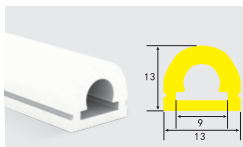

#### YT1313

出光方式 Emitting	半圆/180° 出光 180° glow on sides
适合板宽 Strip width	8mm
产品重量 Weight	125g/m
产品材质 Material	高品质耐黄变纯硅胶 Food-class silicone
包装规格 Package	100米/卷 2卷/箱 100m/roll 2rolls/ctn

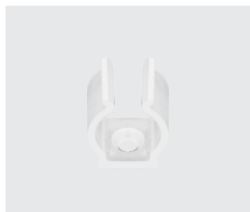
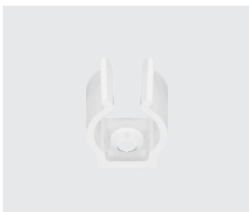

#### YT1311

出光方式 Emitting	半圆/180° 出光 180° glow on sides
适合板宽 Strip width	8mm
产品重量 Weight	110g/m
产品材质 Material	高品质耐黄变纯硅胶 Food-class silicone
包装规格 Package	100米/卷 2卷/箱 100m/roll 2rolls/ctn

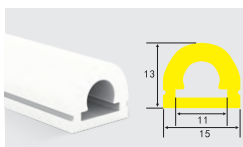

#### YT1513

出光方式 Emitting	半圆/180° 出光 180° glow on sides
适合板宽 Strip width	10mm
产品重量 Weight	140g/m
产品材质 Material	高品质耐黄变纯硅胶 Food-class silicone
包装规格 Package	100米/卷 2卷/箱 100m/roll 2rolls/ctn

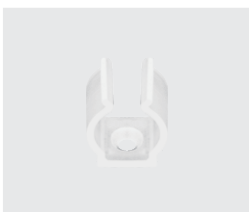

#### D13

出光方式 Emitting	270° 出光 270° glow on sides
适合板宽 Strip width	5/6mm
产品重量 Weight	125g/m
产品材质 Material	高品质耐黄变纯硅胶 Food-class silicone
包装规格 Package	100米/卷 2卷/箱 100m/roll 2rolls/ctn

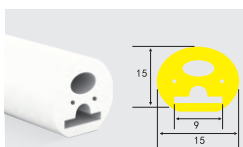

#### D15

出光方式 Emitting	270° 出光 270° glow on sides
适合板宽 Strip width	8mm
产品重量 Weight	170g/m
产品材质 Material	高品质耐黄变纯硅胶 Food-class silicone
包装规格 Package	50米/卷 2卷/箱 50m/roll 2rolls/ctn

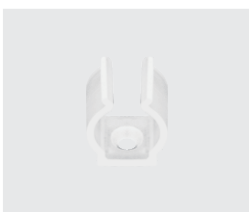

## 270° / 360° 发光系列

270° / 360° Emitting

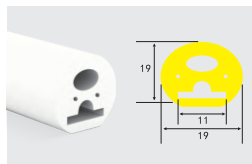

### D19

出光方式 Emitting	270° 出光 270° glow on sides
适合板宽 Strip width	10mm
产品重量 Weight	300g/m
产品材质 Material	高品质耐黄变纯硅胶 Food-class silicone
包装规格 Package	50米/卷 2卷/箱 50m/roll 2rolls/ctn

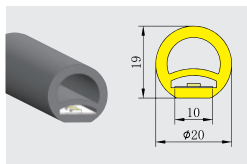

### D20带防断

出光方式 Emitting	270° 出光 270° glow on sides
适合板宽 Strip width	10mm
产品重量 Weight	260g/m
产品材质 Material	高品质耐黄变纯硅胶 Food-class silicone
包装规格 Package	50米/卷 2卷/箱 50m/roll 2rolls/ctn

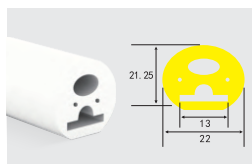

### D22

出光方式 Emitting	270° 出光 270° glow on sides
适合板宽 Strip width	12mm
产品重量 Weight	350g/m
产品材质 Material	高品质耐黄变纯硅胶 Food-class silicone
包装规格 Package	50米/卷 2卷/箱 50m/roll 2rolls/ctn

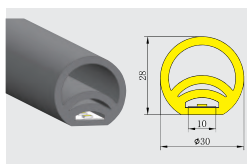

### D30带防断

出光方式 Emitting	270° 出光 270° glow on sides
适合板宽 Strip width	10mm
产品重量 Weight	600g/m
产品材质 Material	高品质耐黄变纯硅胶 Food-class silicone
包装规格 Package	50米/箱 50m/ctn

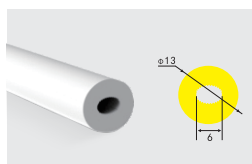
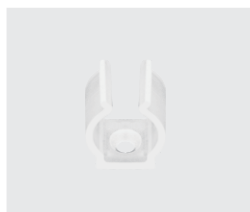

### C13

出光方式 Emitting	360° 出光 360° glow on sides
适合板宽 Strip width	5mm
产品重量 Weight	145g/m
产品材质 Material	高品质耐黄变纯硅胶 Food-class silicone
包装规格 Package	100米/卷 2卷/箱 100m/roll 2rolls/ctn



### C15

出光方式 Emitting	360° 出光 360° glow on sides
适合板宽 Strip width	5/6mm
产品重量 Weight	164g/m
产品材质 Material	高品质耐黄变纯硅胶 Food-class silicone
包装规格 Package	50米/卷 2卷/箱 50m/roll 2rolls/ctn

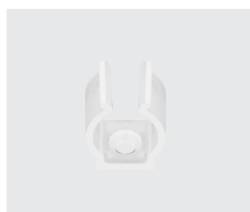
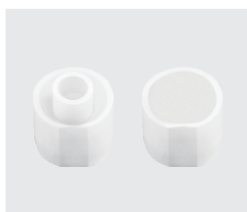
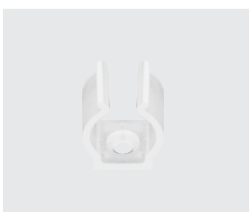



## 360° 发光系列

### 360° Emitting

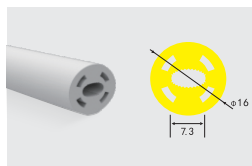

### C16

出光方式 Emitting	360° 出光 360° glow on sides
适合板宽 Strip width	5/6mm
产品重量 Weight	200g/m
产品材质 Material	高品质耐黄变纯硅胶 Food-class silicone
包装规格 Package	50米/卷 2卷/箱 50m/roll 2rolls/ctn

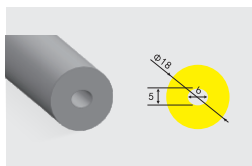
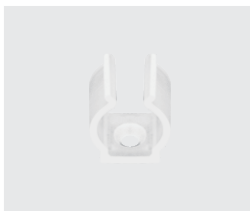

### C18

出光方式 Emitting	360° 出光 360° glow on sides
适合板宽 Strip width	5mm
产品重量 Weight	280g/m
产品材质 Material	高品质耐黄变纯硅胶 Food-class silicone
包装规格 Package	50米/卷 2卷/箱 50m/roll 2rolls/ctn

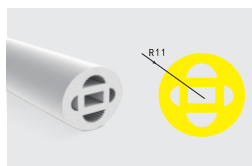
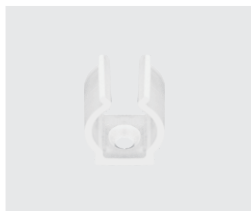

### C22

出光方式 Emitting	360° 出光 360° glow on sides
适合板宽 Strip width	5/6mm
产品重量 Weight	350g/m
产品材质 Material	高品质耐黄变纯硅胶 Food-class silicone
包装规格 Package	50米/卷 2卷/箱 50m/roll 2rolls/ctn

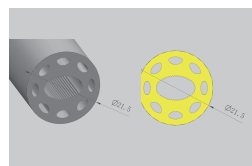

### C22单色

出光方式 Emitting	360° 出光 360° glow on sides
适合板宽 Strip width	10mm
产品重量 Weight	350g/m
产品材质 Material	高品质耐黄变纯硅胶 Food-class silicone
包装规格 Package	50米/卷 2卷/箱 50m/roll 2rolls/ctn

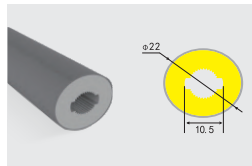
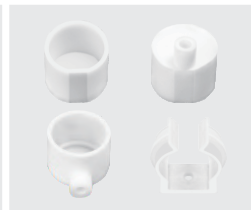

### C22双色

出光方式 Emitting	360° 出光 360° glow on sides
适合板宽 Strip width	8/10mm
产品重量 Weight	400g/m
产品材质 Material	高品质耐黄变纯硅胶 Food-class silicone
包装规格 Package	50米/卷 2卷/箱 50m/roll 2rolls/ctn

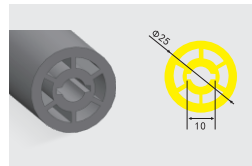

### C25

出光方式 Emitting	360° 出光 360° glow on sides
适合板宽 Strip width	8mm
产品重量 Weight	408g/m
产品材质 Material	高品质耐黄变纯硅胶 Food-class silicone
包装规格 Package	50米/箱 100m/roll



360° 发光系列  
360° Emitting

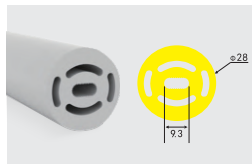

<b>C28</b>	
出光方式 Emitting	360° 出光 360° glow on sides
适合板宽 Strip width	8mm
产品重量 Weight	600g/m
产品材质 Material	高品质耐黄变纯硅胶 Food-class silicone
包装规格 Package	50米/箱 50m/roll

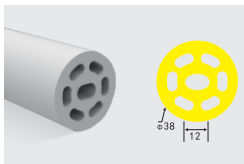

<b>C38老款</b>	
出光方式 Emitting	360° 出光 360° glow on sides
适合板宽 Strip width	10mm
产品重量 Weight	1060g/m
产品材质 Material	高品质耐黄变纯硅胶 Food-class silicone
包装规格 Package	30米/箱 30m/roll

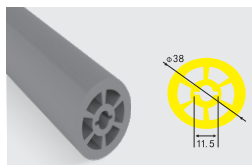

<b>C38新款</b>	
出光方式 Emitting	360° 出光 360° glow on sides
适合板宽 Strip width	10mm
产品重量 Weight	1060g/m
产品材质 Material	高品质耐黄变纯硅胶 Food-class silicone
包装规格 Package	30米/箱 30m/roll



## 经济款系列 Economy Style Series

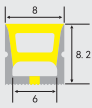
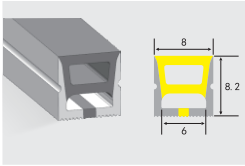

### E0808

出光方式 Emitting	正发光 Side light
适合板宽 Strip width	6mm
产品重量 Weight	67g/m
产品材质 Material	高品质耐黄变纯硅胶 Food-class silicone
包装规格 Package	100米/卷 2卷/箱 100m/roll 2rolls/ctn

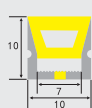
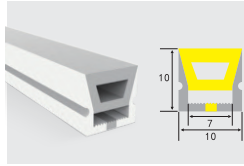

### E1010

出光方式 Emitting	正发光 Side light
适合板宽 Strip width	5/6mm
产品重量 Weight	85g/m
产品材质 Material	高品质耐黄变纯硅胶 Food-class silicone
包装规格 Package	100米/卷 2卷/箱 100m/roll 2rolls/ctn

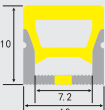
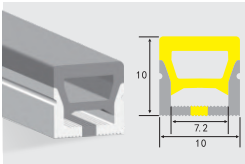
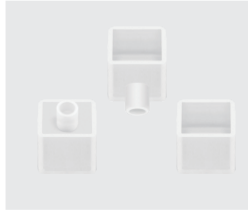
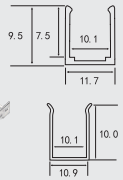
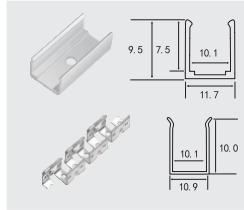
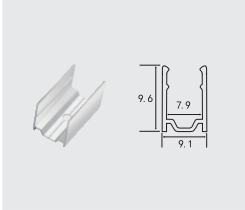

### E1010三面

出光方式 Emitting	正发光 Front light
适合板宽 Strip width	5/6mm
产品重量 Weight	88g/m
产品材质 Material	高品质耐黄变纯硅胶 Food-class silicone
包装规格 Package	100米/卷 2卷/箱 100m/roll 2rolls/ctn

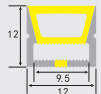
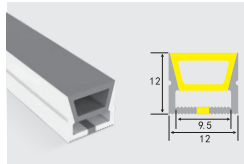

### E1212

出光方式 Emitting	正发光 Front light
适合板宽 Strip width	8mm
产品重量 Weight	103g/m
产品材质 Material	高品质耐黄变纯硅胶 Food-class silicone
包装规格 Package	100米/卷 2卷/箱 100m/roll 2rolls/ctn

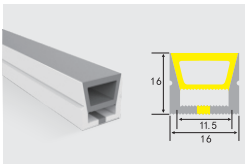
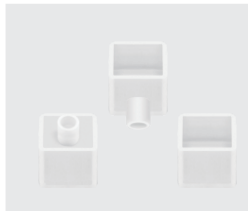
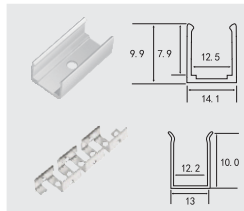
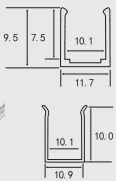
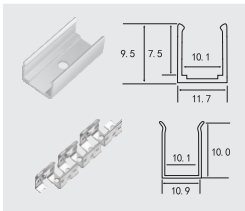

### E1616

出光方式 Emitting	正发光 Front light
适合板宽 Strip width	10mm
产品重量 Weight	183g/m
产品材质 Material	高品质耐黄变纯硅胶 Food-class silicone
包装规格 Package	50米/卷 2卷/箱 50m/roll 2rolls/ctn

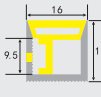
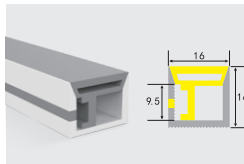

### E1616侧发光

出光方式 Emitting	侧发光 Side light
适合板宽 Strip width	8mm
产品重量 Weight	191g/m
产品材质 Material	高品质耐黄变纯硅胶 Food-class silicone
包装规格 Package	50米/卷 2卷/箱 50m/roll 2rolls/ctn

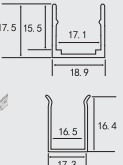
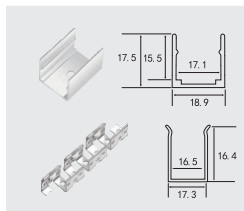
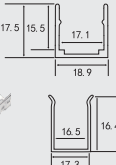
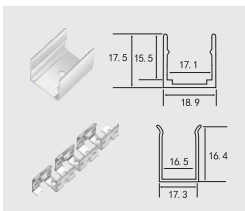

## 经济款系列

### Economy Style Series

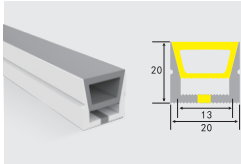

#### E2020

出光方式 Emitting	正发光 Front light
适合板宽 Strip width	10/12mm
产品重量 Weight	256g/m
产品材质 Material	高品质耐黄变纯硅胶 Food-class silicone
包装规格 Package	50米/卷 2卷/箱 50m/roll 2rolls/ctn

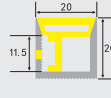
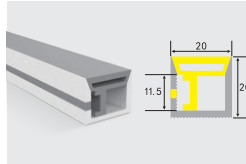

#### E2020侧发光

出光方式 Emitting	侧发光 Side light
适合板宽 Strip width	10mm
产品重量 Weight	256g/m
产品材质 Material	高品质耐黄变纯硅胶 Food-class silicone
包装规格 Package	50米/卷 2卷/箱 50m/roll 2rolls/ctn

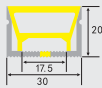
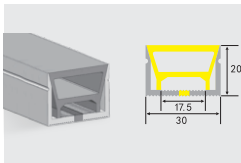
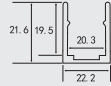
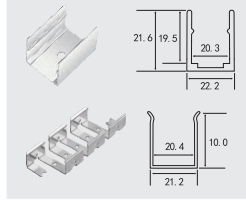
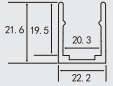
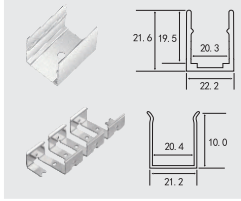

#### E3020

出光方式 Emitting	正发光 Front light
适合板宽 Strip width	15mm
产品重量 Weight	380g/m
产品材质 Material	高品质耐黄变纯硅胶 Food-class silicone
包装规格 Package	50米/箱 50m/roll

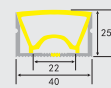
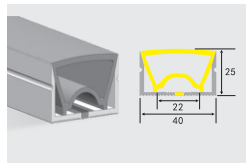

#### E4025

出光方式 Emitting	正发光 Front light
适合板宽 Strip width	20mm
产品重量 Weight	547g/m
产品材质 Material	高品质耐黄变纯硅胶 Food-class silicone
包装规格 Package	30米/箱 30m/ctn

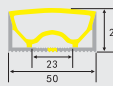
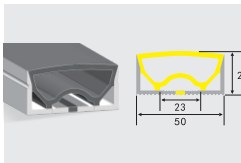
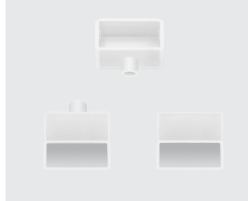
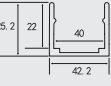
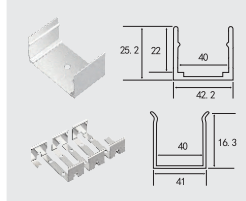
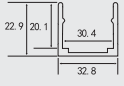
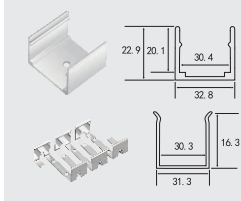

#### E5025

出光方式 Emitting	正发光 Front light
适合板宽 Strip width	20mm
产品重量 Weight	570g/m
产品材质 Material	高品质耐黄变纯硅胶 Food-class silicone
包装规格 Package	30米/箱 30m/roll

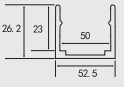
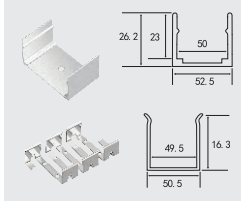

点亮效果

## 经济款系列 Economy Style Series

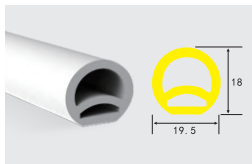

### ED19

出光方式 Emitting	270° 发光 270° light
适合板宽 Strip width	10mm
产品重量 Weight	193g/m
产品材质 Material	高品质耐黄变纯硅胶 Food-class silicone
包装规格 Package	50米/卷 2卷/箱 50m/roll 2rolls/ctn

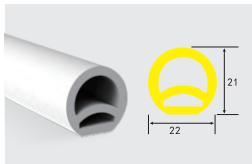

### ED22

出光方式 Emitting	270° 发光 270° light
适合板宽 Strip width	12mm
产品重量 Weight	250g/m
产品材质 Material	高品质耐黄变纯硅胶 Food-class silicone
包装规格 Package	50米/卷 2卷/箱 50m/roll 2rolls/ctn

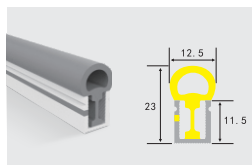
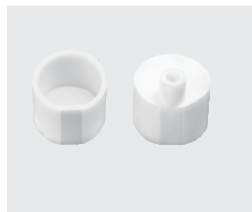

### E1023

出光方式 Emitting	侧发光 Side light
适合板宽 Strip width	10mm
产品重量 Weight	200g/m
产品材质 Material	高品质耐黄变纯硅胶 Food-class silicone
包装规格 Package	50米/卷 2卷/箱 50m/roll 2rolls/ctn

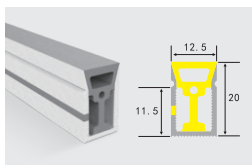

### E1220

出光方式 Emitting	侧发光 Side light
适合板宽 Strip width	10mm
产品重量 Weight	195g/m
产品材质 Material	高品质耐黄变纯硅胶 Food-class silicone
包装规格 Package	50米/卷 2卷/箱 50m/roll 2rolls/ctn

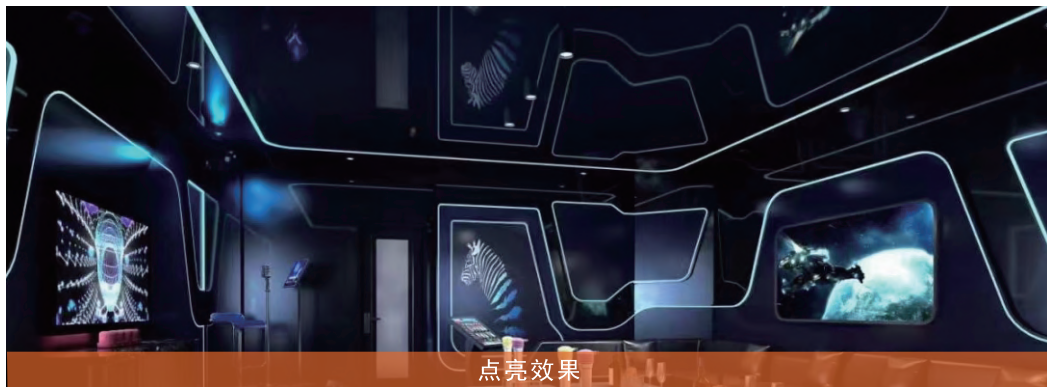
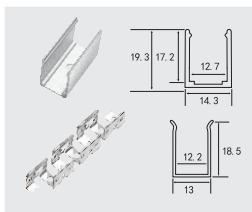
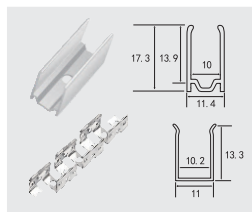

点亮效果

## 发光面罩系列

### Surface Cover Series

#### 6宽分离式硅胶条

出光方式 Emitting	正发光 Front light
适合板宽 Strip width	6mm
产品重量 Weight	64g/m
产品材质 Material	高品质耐黄变纯硅胶 Food-class silicone
包装规格 Package	100米/卷 2卷/箱 100m/roll 2rolls/ctn

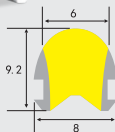

#### 8宽分离式硅胶条

出光方式 Emitting	正发光 Front light
适合板宽 Strip width	8mm
产品重量 Weight	74g/m
产品材质 Material	高品质耐黄变纯硅胶 Food-class silicone
包装规格 Package	100米/卷 2卷/箱 100m/roll 2rolls/ctn

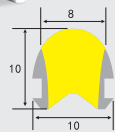

#### 1010有底带边

出光方式 Emitting	正发光 Front light
适合板宽 Strip width	5/6mm
产品重量 Weight	90g/m
产品材质 Material	高品质耐黄变纯硅胶 Food-class silicone
包装规格 Package	100米/卷 2卷/箱 100m/roll 2rolls/ctn

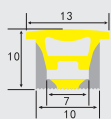

#### 1010无底带边

出光方式 Emitting	正发光 Front light
适合板宽 Strip width	5/6mm
产品重量 Weight	82g/m
产品材质 Material	高品质耐黄变纯硅胶 Food-class silicone
包装规格 Package	100米/卷 2卷/箱 100m/roll 2rolls/ctn

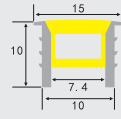

#### 1212无底带边

出光方式 Emitting	正发光 Front light
适合板宽 Strip width	5/6mm
产品重量 Weight	79g/m
产品材质 Material	高品质耐黄变纯硅胶 Food-class silicone
包装规格 Package	100米/卷 2卷/箱 100m/roll 2rolls/ctn

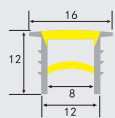

#### 1414无底带边

出光方式 Emitting	正发光 Front light
适合板宽 Strip width	10mm
产品重量 Weight	120g/m
产品材质 Material	高品质耐黄变纯硅胶 Food-class silicone
包装规格 Package	50米/卷 2卷/箱 50m/roll 2rolls/ctn

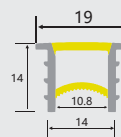

#### YT1616无底

出光方式 Emitting	正发光 Front light
适合板宽 Strip width	10mm
产品重量 Weight	160g/m
产品材质 Material	高品质耐黄变纯硅胶 Food-class silicone
包装规格 Package	50米/卷 2卷/箱 50m/roll 2rolls/ctn

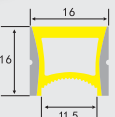

#### 1616无底带边

出光方式 Emitting	正发光 Front light
适合板宽 Strip width	10/12mm
产品重量 Weight	180g/m
产品材质 Material	高品质耐黄变纯硅胶 Food-class silicone
包装规格 Package	50米/卷 2卷/箱 50m/roll 2rolls/ctn

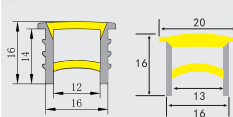

## 发光面罩系列

### Surface Cover Series

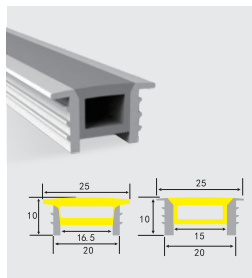

### 2010无底带边

出光方式 正发光  
Emitting Front light

适合板宽 10/12mm  
Strip width

产品重量 120g/m  
Weight

产品材质 高品质耐黄变纯硅胶  
Material Food-class silicone

包装规格 50米/卷 2卷/箱  
Package 50m/roll 2rolls/ctn

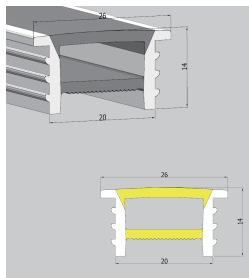

### 2014无底带边

出光方式 正发光  
Emitting Front light

适合板宽 10/12mm  
Strip width

产品重量 195g/m  
Weight

产品材质 高品质耐黄变纯硅胶  
Material Food-class silicone

包装规格 50米/卷 2卷/箱  
Package 50m/roll 2rolls/ctn

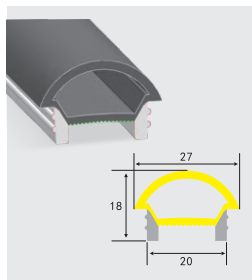

### 2018无底弧面

出光方式 正发光  
Emitting Front light

适合板宽 10/12mm  
Strip width

产品重量 195g/m  
Weight

产品材质 高品质耐黄变纯硅胶  
Material Food-class silicone

包装规格 50米/卷 2卷/箱  
Package 50m/roll 2rolls/ctn

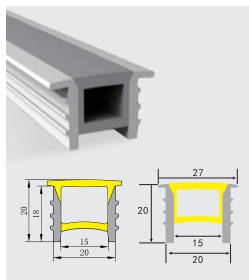

### 2020无底带边

出光方式 正发光  
Emitting Front light

适合板宽 10/12mm  
Strip width

产品重量 216g/m  
Weight

产品材质 高品质耐黄变纯硅胶  
Material Food-class silicone

包装规格 50米/卷 2卷/箱  
Package 50m/roll 2rolls/ctn

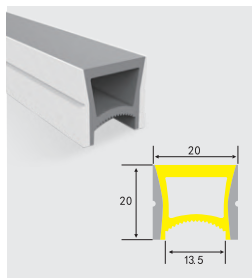

### 2020无底

出光方式 正发光  
Emitting Front light

适合板宽 10/12mm  
Strip width

产品重量 220g/m  
Weight

产品材质 高品质耐黄变纯硅胶  
Material Food-class silicone

包装规格 50米/卷 2卷/箱  
Package 50m/roll 2rolls/ctn

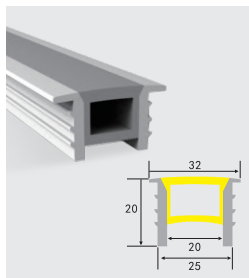

### 2520无底带边

出光方式 正发光  
Emitting Front light

适合板宽 20mm  
Strip width

产品重量 276g/m  
Weight

产品材质 高品质耐黄变纯硅胶  
Material Food-class silicone

包装规格 50米/卷 2卷/箱  
Package 50m/roll 2rolls/ctn

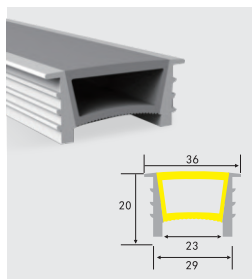

### 3020无底带边

出光方式 正发光  
Emitting Front light

适合板宽 20mm  
Strip width

产品重量 300g/m  
Weight

产品材质 高品质耐黄变纯硅胶  
Material Food-class silicone

包装规格 50米/卷 2卷/箱  
Package 50m/roll 2rolls/ctn

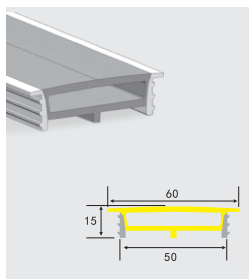

### 5015无底带边

出光方式 正发光  
Emitting Front light

适合板宽 20mm  
Strip width

产品重量 384g/m  
Weight

产品材质 高品质耐黄变纯硅胶  
Material Food-class silicone

包装规格 50米/卷 2卷/箱  
Package 50m/roll 2rolls/ctn

### 发光面罩系列 Surface Cover Series

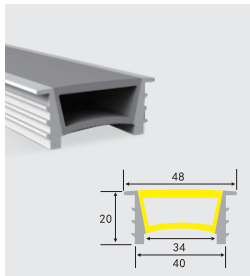

#### 4020无底带边

出光方式 Emitting	正发光 Front light
适合板宽 Strip width	20mm
产品重量 Weight	370g/m
产品材质 Material	高品质耐黄变纯硅胶 Food-class silicone
包装规格 Package	50米/卷 2卷/箱 50m/roll 2rolls/ctn

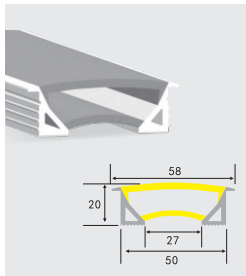

#### 5020无底带边

出光方式 Emitting	正发光 Front light
适合板宽 Strip width	20mm
产品重量 Weight	538g/m
产品材质 Material	高品质耐黄变纯硅胶 Food-class silicone
包装规格 Package	50米/卷 2卷/箱 50m/roll 2rolls/ctn



### 点亮效果



## 透镜套管系列

Wall Washer Tubes

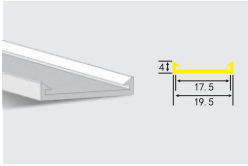

### YT17洗墙灯半套管

出光方式 Emitting	正发光 Front light
适合板宽 Strip width	17mm
产品重量 Weight	36g/m
产品材质 Material	高品质耐黄变硅胶 Food-class silicone
包装规格 Package	200米/箱 200m/roll

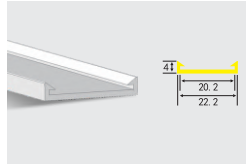

### YT20洗墙灯半套管

出光方式 Emitting	正发光 Front light
适合板宽 Strip width	20mm
产品重量 Weight	70g/m
产品材质 Material	高品质耐黄变硅胶 Food-class silicone
包装规格 Package	200米/箱 200m/roll



点亮效果



点亮效果

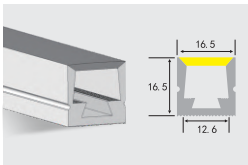

### T16 透镜灯带套管

出光方式 Emitting	正发光 Front light
适合板宽 Strip width	12mm
产品重量 Weight	175g/m
产品材质 Material	高品质耐黄变硅胶 Food-class silicone
包装规格 Package	50米/卷 2卷/箱 50m/roll 2rolls/ctn

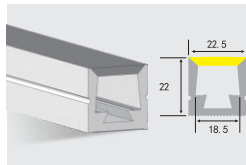

### T22 透灯带套管

出光方式 Emitting	正发光 Front light
适合板宽 Strip width	18mm
产品重量 Weight	300g/m
产品材质 Material	高品质耐黄变硅胶 Food-class silicone
包装规格 Package	50米/箱 50m/roll

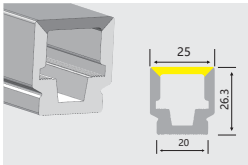
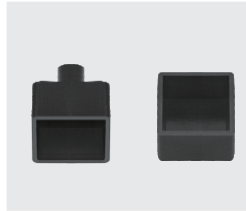

### T2526

出光方式 Emitting	正发光 front light
适合板宽 Strip width	20mm
产品重量 Weight	400g/m
产品材质 Material	高品质耐黄变硅胶 Food-class silicone
包装规格 Package	50米/箱 50m/ctn

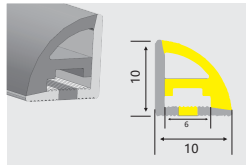

### 1010扇形

出光方式 Emitting	侧发光 Side light
适合板宽 Strip width	5mm
产品重量 Weight	70g/m
产品材质 Material	高品质耐黄变硅胶 Food-class silicone
包装规格 Package	100米/卷 2卷/箱 100m/roll 2rolls/ctn

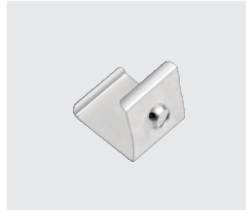
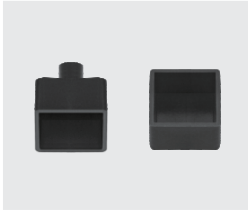

## 透镜套管系列

### Wall Washer Tubes

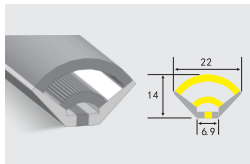

#### V22 扇形套管

出光方式 Emitting	侧发光 Side light
适合板宽 Strip width	5mm
产品重量 Weight	160g/m
产品材质 Material	高品质耐黄变硅胶 Food-class silicone
包装规格 Package	50米/卷 2卷/箱 50m/roll 2rolls/ctn

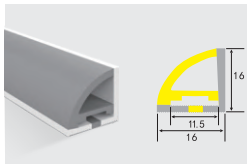

#### 1616 扇形套管

出光方式 Emitting	侧发光 Side light
适合板宽 Strip width	10mm
产品重量 Weight	162g/m
产品材质 Material	高品质耐黄变硅胶 Food-class silicone
包装规格 Package	50米/卷 2卷/箱 50m/roll 2rolls/ctn

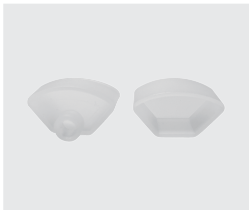

## 点亮效果

## 黑色套管系列 Black Tube Series

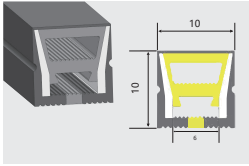

### YT1010全黑

出光方式 Emitting	正发光 Front light
适合板宽 Strip width	5mm
产品重量 Weight	100g/m
产品材质 Material	高品质耐黄变纯硅胶 Food-class silicone
包装规格 Package	100米/卷 2卷/箱 100m/roll 2rolls/ctn

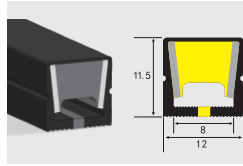
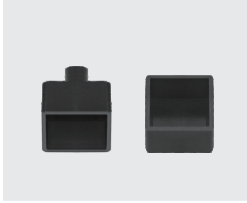
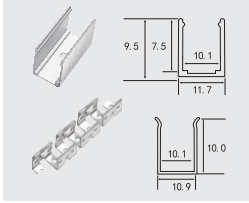

### YT1212全黑

出光方式 Emitting	正发光 Front light
适合板宽 Strip width	8mm
产品重量 Weight	148g/m
产品材质 Material	高品质耐黄变纯硅胶 Food-class silicone
包装规格 Package	100米/卷 2卷/箱 100m/roll 2rolls/ctn

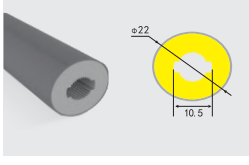
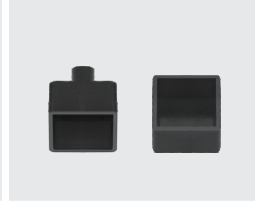
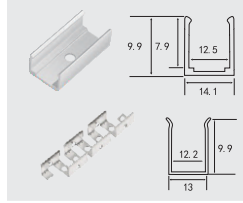

### C22全黑

出光方式 Emitting	360° 出光 360° glow on sides
适合板宽 Strip width	8/10mm
产品重量 Weight	400g/m
产品材质 Material	高品质耐黄变纯硅胶 Food-class silicone
包装规格 Package	50米/卷 2卷/箱 50m/roll 2rolls/ctn

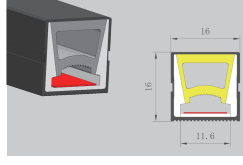

### YT1616全黑防断

出光方式 Emitting	正发光 Front light
适合板宽 Strip width	10mm
产品重量 Weight	220g/m
产品材质 Material	高品质耐黄变纯硅胶 Food-class silicone
包装规格 Package	50米/卷 2卷/箱 50m/roll 2rolls/ctn

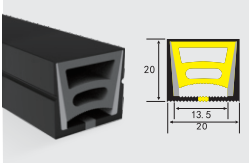
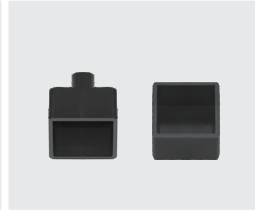
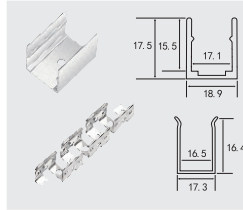

### YT2020全黑

出光方式 Emitting	正发光 Front light
适合板宽 Strip width	12mm
产品重量 Weight	323g/m
产品材质 Material	高品质耐黄变纯硅胶 Food-class silicone
包装规格 Package	50米/卷 2卷/箱 50m/roll 2rolls/ctn

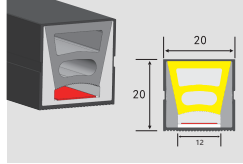
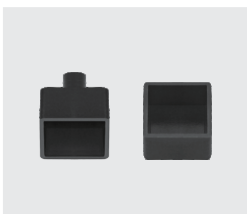
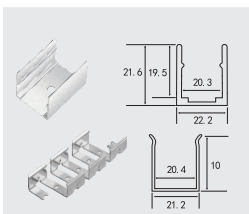

### YT2020全黑防断

出光方式 Emitting	正发光 Front light
适合板宽 Strip width	12mm
产品重量 Weight	360g/m
产品材质 Material	高品质耐黄变纯硅胶 Food-class silicone
包装规格 Package	50米/卷 2卷/箱 50m/roll 2rolls/ctn

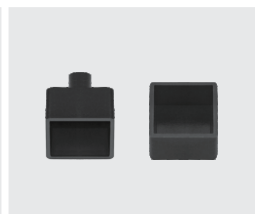
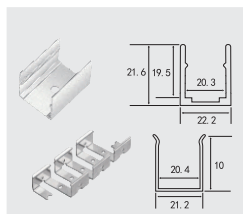

## 黑色套管系列 Black Tube Series

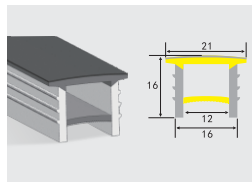

### 1616无底带边黑面

出光方式 Emitting	正发光 Front light
适合板宽 Strip width	12mm
产品重量 Weight	144g/m
产品材质 Material	高品质耐黄变纯硅胶 Food-class silicone
包装规格 Package	50米/卷 2卷/箱 50m/roll 2rolls/ctn

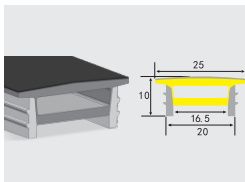

### 2010无底带边黑面

出光方式 Emitting	正发光 Front light
适合板宽 Strip width	10/12mm
产品重量 Weight	130g/m
产品材质 Material	高品质耐黄变纯硅胶 Food-class silicone
包装规格 Package	50米/卷 2卷/箱 50m/roll 2rolls/ctn

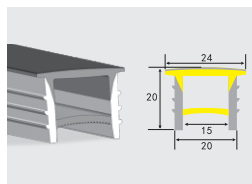

### 2020无底带边黑面

出光方式 Emitting	正发光 Front light
适合板宽 Strip width	10/12mm
产品重量 Weight	216g/m
产品材质 Material	高品质耐黄变纯硅胶 Food-class silicone
包装规格 Package	50米/卷 2卷/箱 50m/roll 2rolls/ctn

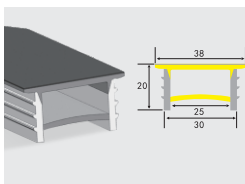

### 3020无底带边黑面

出光方式 Emitting	正发光 Front light
适合板宽 Strip width	10/12mm
产品重量 Weight	300g/m
产品材质 Material	高品质耐黄变纯硅胶 Food-class silicone
包装规格 Package	50米/卷 2卷/箱 50m/roll 2rolls/ctn



## 点亮效果

## 内置防断系列 Built-in Pet Sheet Tubes

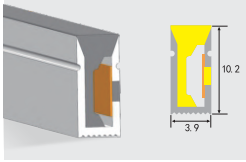

### YT0410带防断片

出光方式 Emitting	侧发光 Side light
适合板宽 Strip width	5mm
产品重量 Weight	38g/m
产品材质 Material	高品质耐黄变纯硅胶 Food-class silicone
包装规格 Package	100米/卷 2卷/箱 100m/roll 2rolls/ctn

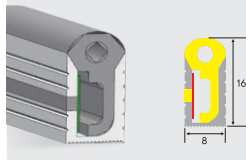

### YT0816防断款

出光方式 Emitting	侧发光 Side light
适合板宽 Strip width	8mm
产品重量 Weight	118g/m
产品材质 Material	高品质耐黄变纯硅胶 Food-class silicone
包装规格 Package	50米/卷 2卷/箱 50m/roll 2rolls/ctn

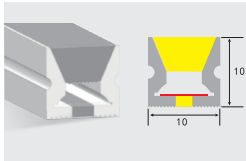
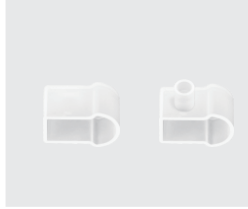
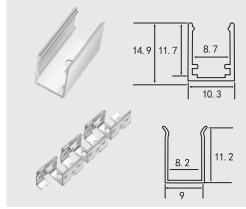
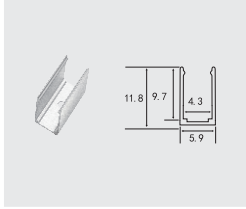

### YT1010带防断片

出光方式 Emitting	正发光 Front light
适合板宽 Strip width	6/8mm
产品重量 Weight	100g/m
产品材质 Material	高品质耐黄变纯硅胶 Food-class silicone
包装规格 Package	100米/卷 2卷/箱 100m/roll 2rolls/ctn

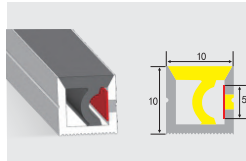

### YT1010侧发光三色带防断片

出光方式 Emitting	侧发光 Side light
适合板宽 Strip width	5mm
产品重量 Weight	88g/m
产品材质 Material	高品质耐黄变纯硅胶 Food-class silicone
包装规格 Package	100米/卷 2卷/箱 100m/roll 2rolls/ctn

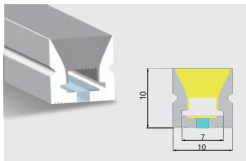
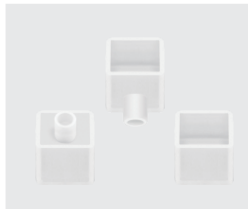
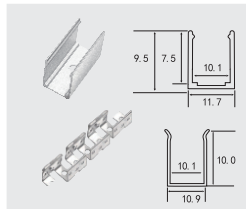
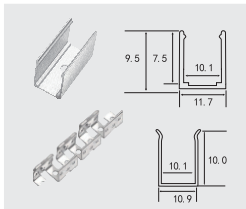

### YT1010正发光三色

出光方式 Emitting	正发光 Front light
适合板宽 Strip width	6mm
产品重量 Weight	100g/m
产品材质 Material	高品质耐黄变纯硅胶 Food-class silicone
包装规格 Package	100米/卷 2卷/箱 100m/roll 2rolls/ctn

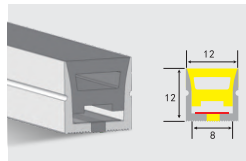

### YT1212 带防断

出光方式 Emitting	正发光 Front light
适合板宽 Strip width	8mm
产品重量 Weight	120g/m
产品材质 Material	高品质耐黄变纯硅胶 Food-class silicone
包装规格 Package	100米/卷 2卷/箱 100m/roll 2rolls/ctn

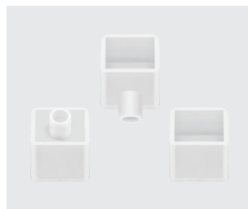
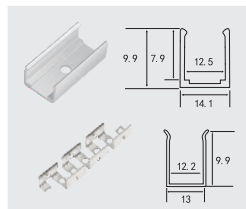
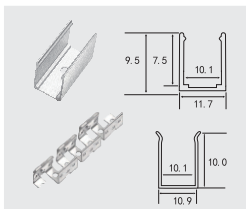

## 内置防断系列

### Built-in Pet Sheet Tubes

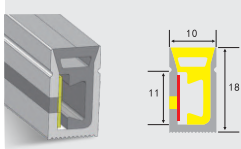

#### YT1018 防断款

出光方式 Emitting	侧发光 Side light
适合板宽 Strip width	10mm
产品重量 Weight	162g/m
产品材质 Material	高品质耐黄变纯硅胶 Food-class silicone
包装规格 Package	50米/卷 2卷/箱 50m/roll 2rolls/ctn

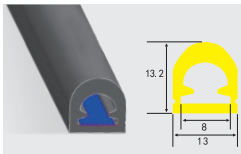

#### YT1313 半圆防断款

出光方式 Emitting	半圆/180° 出光 180° glow on sides
适合板宽 Strip width	8mm
产品重量 Weight	125g/m
产品材质 Material	高品质耐黄变纯硅胶 Food-class silicone
包装规格 Package	100米/卷 2卷/箱 100m/roll 2rolls/ctn

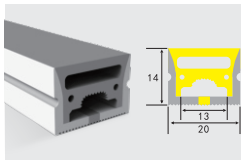
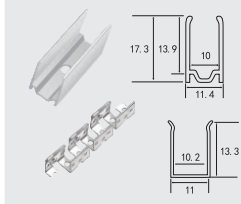

#### YT2014 单面防断款

出光方式 Emitting	正发光 Front light
适合板宽 Strip width	12mm
产品重量 Weight	247g/m
产品材质 Material	高品质耐黄变纯硅胶 Food-class silicone
包装规格 Package	50米/卷 2卷/箱 50m/roll 2rolls/ctn

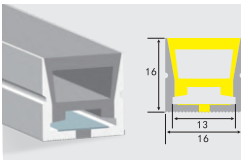

#### YT1616 正发光防断款

出光方式 Emitting	正发光 Front light
适合板宽 Strip width	10mm
产品重量 Weight	214g/m
产品材质 Material	高品质耐黄变纯硅胶 Food-class silicone
包装规格 Package	50米/卷 2卷/箱 50m/roll 2rolls/ctn

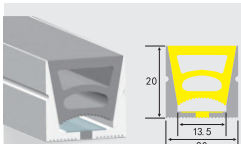
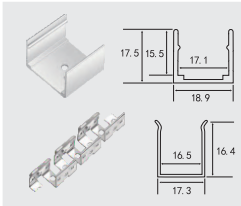
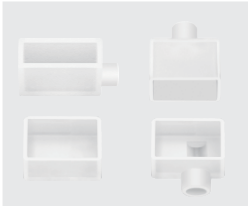
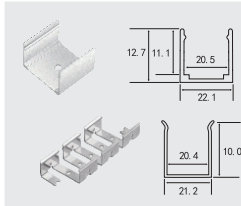

#### YT2020 正发光防断款

出光方式 Emitting	正发光 Front light
适合板宽 Strip width	12mm
产品重量 Weight	330g/m
产品材质 Material	高品质耐黄变纯硅胶 Food-class silicone
包装规格 Package	50米/卷 2卷/箱 50m/roll 2rolls/ctn

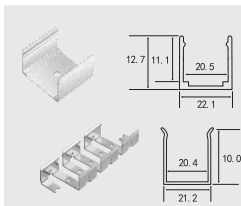

点亮效果

## 常用单色套管系列 Common LED Strip Tubes

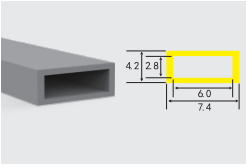

### YT05 5宽套管

颜色 Color	透明/乳白 Transparent/milky white
适合板宽 Strip width	5mm
产品重量 Weight	18g/m
产品材质 Material	高品质耐黄变纯硅胶 Food-class silicone
包装规格 Package	250米/卷 4卷/箱 250m/roll 4rolls/ctn

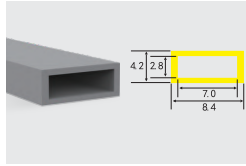

### YT06 6宽套管

颜色 Color	透明/乳白 Transparent/milky white
适合板宽 Strip width	6mm
产品重量 Weight	20g/m
产品材质 Material	高品质耐黄变纯硅胶 Food-class silicone
包装规格 Package	250米/卷 4卷/箱 250m/roll 4rolls/ctn

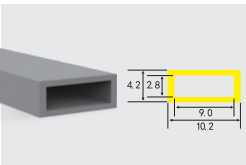
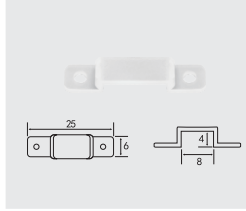
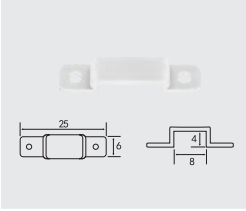

### YT08 8宽套管

颜色 Color	透明/乳白 Transparent/milky white
适合板宽 Strip width	8mm
产品重量 Weight	16g/m
产品材质 Material	高品质耐黄变纯硅胶 Food-class silicone
包装规格 Package	250米/卷 4卷/箱 250m/roll 4rolls/ctn

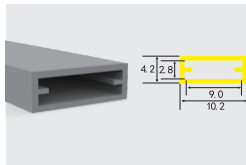

### YT08 8宽带卡

颜色 Color	透明/乳白 Transparent/milky white
适合板宽 Strip width	8mm
产品重量 Weight	23g/m
产品材质 Material	高品质耐黄变纯硅胶 Food-class silicone
包装规格 Package	250米/卷 4卷/箱 250m/roll 4rolls/ctn

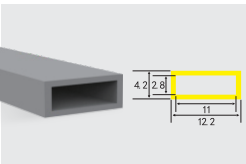
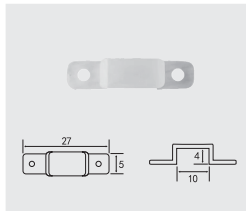
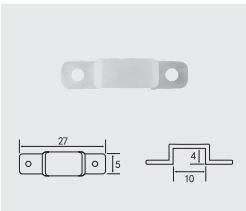

### YT10 10宽套管

颜色 Color	透明/乳白 Transparent/milky white
适合板宽 Strip width	10mm
产品重量 Weight	20g/m
产品材质 Material	高品质耐黄变纯硅胶 Food-class silicone
包装规格 Package	250米/卷 4卷/箱 250m/roll 4rolls/ctn

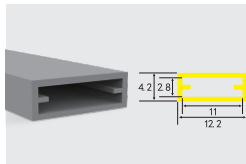

### YT10 10宽带卡

颜色 Color	透明/乳白 Transparent/milky white
适合板宽 Strip width	10mm
产品重量 Weight	27g/m
产品材质 Material	高品质耐黄变纯硅胶 Food-class silicone
包装规格 Package	250米/卷 4卷/箱 250m/roll 4rolls/ctn

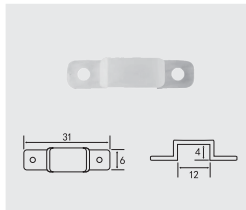
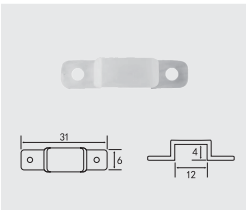

## 常用单色套管系列 Common LED Strip Tubes

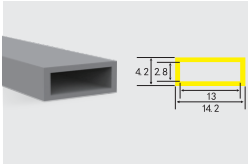

### YT12 12宽套管

颜色 Color	透明/乳白 Transparent/milky white
适合板宽 Strip width	12mm
产品重量 Weight	28g/m
产品材质 Material	高品质耐黄变纯硅胶 Food-class silicone
包装规格 Package	200米/卷 4卷/箱 200m/roll 4rolls/ctn

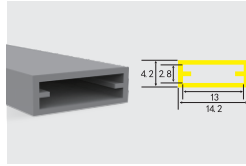

### YT12 12宽带卡

颜色 Color	透明/乳白 Transparent/milky white
适合板宽 Strip width	12mm
产品重量 Weight	34g/m
产品材质 Material	高品质耐黄变纯硅胶 Food-class silicone
包装规格 Package	200米/卷 4卷/箱 200m/roll 4rolls/ctn

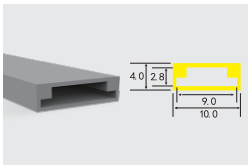
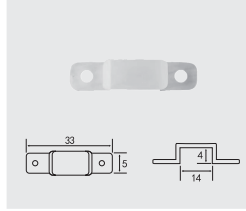
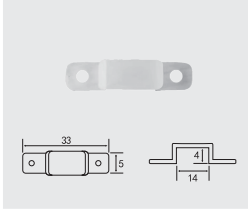

### YT08 8宽内凸

颜色 Color	透明/乳白 Transparent/milky white
适合板宽 Strip width	8mm
产品重量 Weight	27g/m
产品材质 Material	高品质耐黄变纯硅胶 Food-class silicone
包装规格 Package	250米/卷 4卷/箱 250m/roll 4rolls/ctn

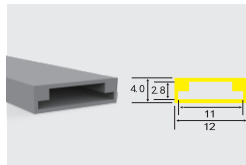

### YT10 10宽内凸

颜色 Color	透明/乳白 Transparent/milky white
适合板宽 Strip width	10mm
产品重量 Weight	33g/m
产品材质 Material	高品质耐黄变纯硅胶 Food-class silicone
包装规格 Package	250米/卷 4卷/箱 250m/roll 4rolls/ctn

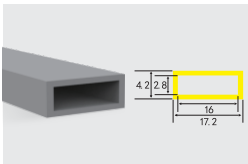
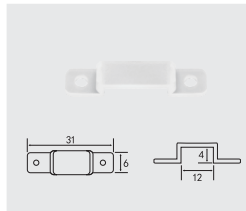
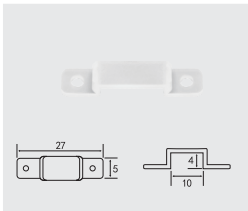

### YT15宽套管

颜色 Color	透明/乳白 Transparent/milky white
适合板宽 Strip width	15mm
产品重量 Weight	37g/m
产品材质 Material	高品质耐黄变纯硅胶 Food-class silicone
包装规格 Package	200米/卷 4卷/箱 200m/roll 4rolls/ctn

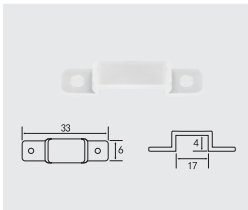

点亮效果



## 常用单色套管系列 Common LED Strip Tubes

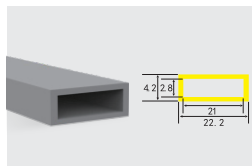

### Y20宽套管

颜色 Color	透明/乳白 Transparent/milky white
适合板宽 Strip width	20mm
产品重量 Weight	53g/m
产品材质 Material	高品质耐黄变纯硅胶 Food-class silicone
包装规格 Package	150米/卷 4卷/箱 150m/roll 4rolls/ctn

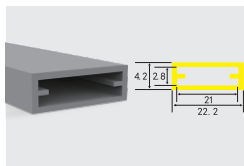

### Y20宽带卡

颜色 Color	透明/乳白 Transparent/milky white
适合板宽 Strip width	20mm
产品重量 Weight	50g/m
产品材质 Material	高品质耐黄变纯硅胶 Food-class silicone
包装规格 Package	150米/卷 4卷/箱 150m/roll 4rolls/ctn

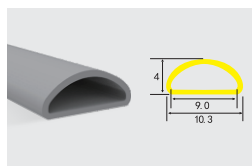
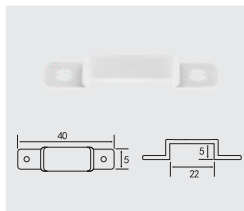
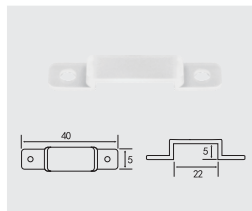

### Y08 8月牙

颜色 Color	透明/乳白 Transparent/milky white
适合板宽 Strip width	8mm
产品重量 Weight	18g/m
产品材质 Material	高品质耐黄变纯硅胶 Food-class silicone
包装规格 Package	250米/卷 4卷/箱 250m/roll 4rolls/ctn

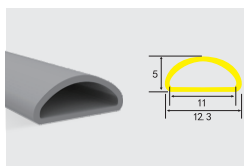

### Y10 10月牙

颜色 Color	透明/乳白 Transparent/milky white
适合板宽 Strip width	10mm
产品重量 Weight	25g/m
产品材质 Material	高品质耐黄变纯硅胶 Food-class silicone
包装规格 Package	250米/卷 4卷/箱 250m/roll 4rolls/ctn

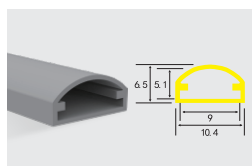
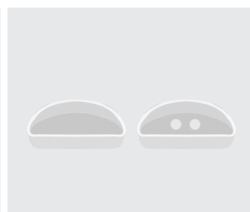
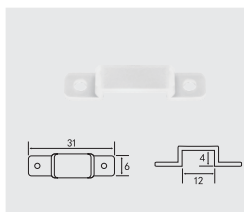
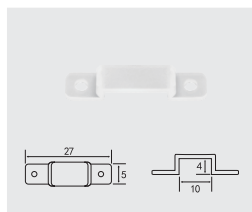

### Y8宽半圆乳白内卡

颜色 Color	透明/乳白 Transparent/milky white
适合板宽 Strip width	8mm
产品重量 Weight	30g/m
产品材质 Material	高品质耐黄变纯硅胶 Food-class silicone
包装规格 Package	100米/卷 4卷/箱 100m/roll 4rolls/ctn

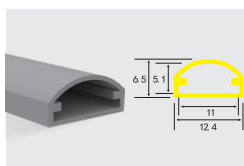

### Y10宽半圆乳白内卡

颜色 Color	透明/乳白 Transparent/milky white
适合板宽 Strip width	10mm
产品重量 Weight	49g/m
产品材质 Material	高品质耐黄变纯硅胶 Food-class silicone
包装规格 Package	100米/卷 4卷/箱 100m/roll 4rolls/ctn



## 常用单色套管系列 Common LED Strip Tubes

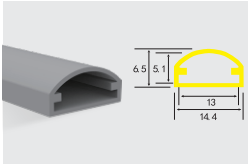

### YT12宽半圆乳白内卡

颜色 Color	透明/乳白 Transparent/milky white
适合板宽 Strip width	12mm
产品重量 Weight	59g/m
产品材质 Material	高品质耐黄变纯硅胶 Food-class silicone
包装规格 Package	100米/卷 4卷/箱 100m/roll 4rolls/ctn

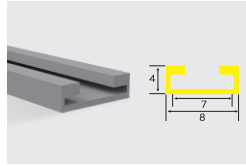
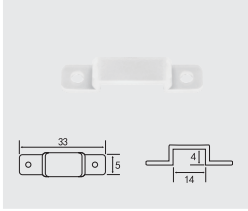

### YT06 6宽半套管

颜色 Color	透明 Transparent
适合板宽 Strip width	6mm
产品重量 Weight	20g/m
产品材质 Material	高品质耐黄变纯硅胶 Food-class silicone
包装规格 Package	250米/卷 4卷/箱 250m/roll 4rolls/ctn

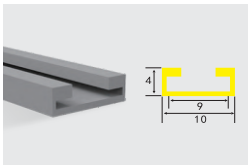
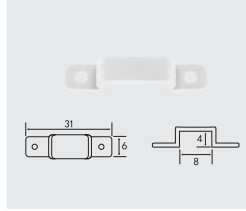

### YT08 8宽半套管

颜色 Color	透明 Milky white
适合板宽 Strip width	8mm
产品重量 Weight	16g/m
产品材质 Material	高品质耐黄变纯硅胶 Food-class silicone
包装规格 Package	250米/卷 4卷/箱 250m/roll 4rolls/ctn

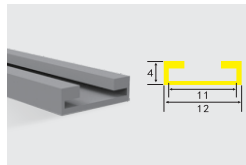
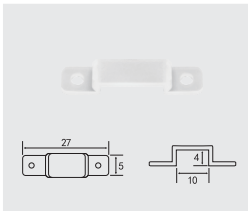

### YT10 10宽半套管

颜色 Color	透明 Transparent
适合板宽 Strip width	10mm
产品重量 Weight	20g/m
产品材质 Material	高品质耐黄变纯硅胶 Food-class silicone
包装规格 Package	250米/卷 4卷/箱 250m/roll 4rolls/ctn

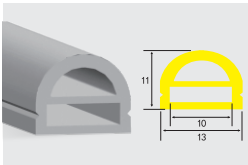
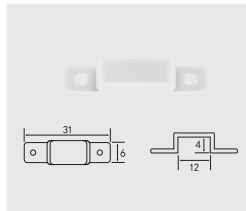

### YT8宽双层乳白

颜色 Color	乳白 Milky white
适合板宽 Strip width	8mm
产品重量 Weight	100g/m
产品材质 Material	高品质耐黄变纯硅胶 Food-class silicone
包装规格 Package	100米/卷 4卷/箱 100m/roll 4rolls/ctn

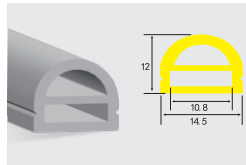
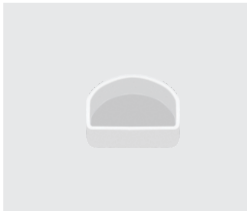
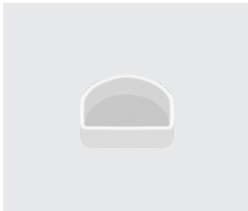

### YT10宽双层乳白

颜色 Color	乳白 Milky white
适合板宽 Strip width	10mm
产品重量 Weight	110g/m
产品材质 Material	高品质耐黄变纯硅胶 Food-class silicone
包装规格 Package	100米/卷 4卷/箱 100m/roll 4rolls/ctn

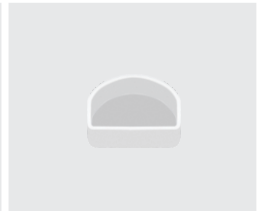
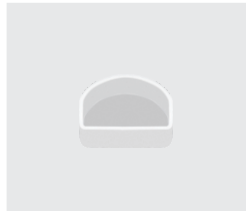

## 共挤加工系列

Co-extrusion Process Neon Strips

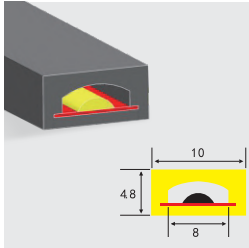

### 8宽空心共挤

出光方式 正发光  
Emitting Front light

适合板宽 8mm  
Strip width

产品重量 28g/m  
Weight

产品材质 高品质耐黄变纯硅胶  
Material Food-class silicone

尾端工艺 堵头打胶  
Tail end process Plug gluing

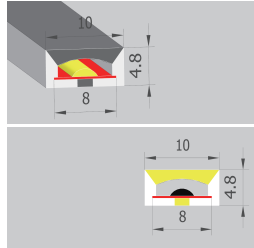

### 8宽双色共挤(可加防断片)

出光方式 正发光  
Emitting head light

适合板宽 8mm  
Strip width

产品重量 32g/m  
Weight

产品材质 高品质耐黄变纯硅胶  
Material Food-class silicone

尾端工艺 堵头打胶  
Tail process Glue the plug

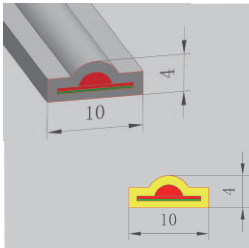

### COB 8宽D型共挤

出光方式 正发光  
Emitting Front light

适合板宽 8mm  
Strip width

产品重量 35g/m  
Weight

产品材质 高品质耐黄变纯硅胶  
Material Food-class silicone

尾端工艺 堵头打胶  
Tail end process Plug gluing

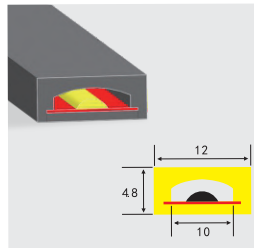

### 10宽空心共挤

出光方式 正发光  
Emitting Front light

适合板宽 10mm  
Strip width

产品重量 35g/m  
Weight

产品材质 高品质耐黄变纯硅胶  
Material Food-class silicone

尾端工艺 堵头打胶  
Tail end process Plug gluing

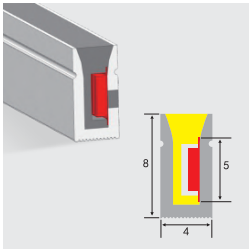

### 0408共挤

出光方式 侧发光  
Emitting Side light

适合板宽 5mm  
Strip width

产品重量 40g/m  
Weight

产品材质 高品质耐黄变纯硅胶  
Material Food-class silicone

尾端工艺 堵头打胶/液压堵头  
Tail end process Plug gluing/hydraulic plug

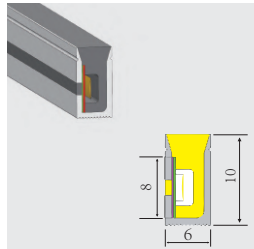

### 0612共挤(带防断)

出光方式 侧发光  
Emitting Side light

适合板宽 8mm  
Strip width

产品重量 75g/m  
Weight

产品材质 高品质耐黄变纯硅胶  
Material Food-class silicone

尾端工艺 堵头打胶/液压堵头  
Tail process Plug gluing/hydraulic plug

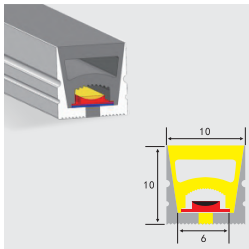

### 1010共挤(带防断)

出光方式 正发光  
Emitting Front light

适合板宽 5/6/8mm  
Strip width

产品重量 98g/m  
Weight

产品材质 高品质耐黄变纯硅胶  
Material Food-class silicone

尾端工艺 堵头打胶/液压堵头  
Tail end process Plug gluing/hydraulic plug

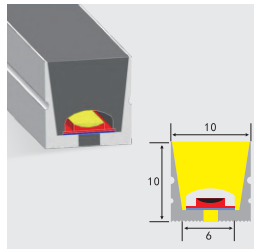

### 1010共挤(带防断)

出光方式 正发光  
Emitting Front light

适合板宽 6mm  
Strip width

产品重量 115g/m  
Weight

产品材质 高品质耐黄变纯硅胶  
Material Food-class silicone

尾端工艺 堵头打胶/液压堵头  
Tail end process Plug gluing/hydraulic plug

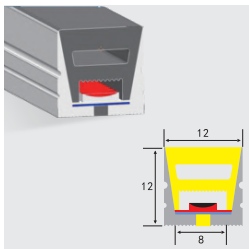

### 1212共挤(带防断)

出光方式 正发光  
Emitting Front light

适合板宽 8/10mm  
Strip width

产品重量 132g/m  
Weight

产品材质 高品质耐黄变纯硅胶  
Material Food-class silicone

尾端工艺 堵头打胶/液压堵头  
Tail end process Plug gluing/hydraulic plug

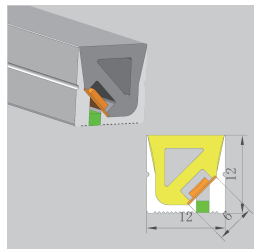

### 1212 3D共挤(带防断)

出光方式 正发光  
Emitting Front light

适合板宽 6mm  
Strip width

产品重量 115g/m  
Weight

产品材质 高品质耐黄变纯硅胶  
Material Food-class silicone

尾端工艺 堵头打胶/液压堵头  
Tail end process Plug gluing/hydraulic plug

## 共挤加工系列

Co-extrusion Process Neon Strips

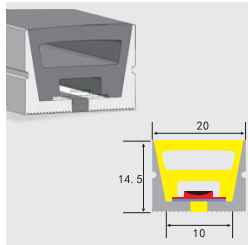

### 2014共挤(带防断)

出光方式 Emitting	正发光 Front light
适合板宽 Strip width	10mm
产品重量 Weight	264g/m
产品材质 Material	高品质耐黄变纯硅胶 Food-class silicone
尾端工艺 Tail end process	堵头打胶/液压堵头 Plug gluing/hydraulic plug

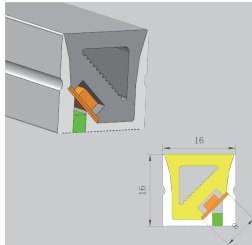

### 1616 3D共挤(带防断)

出光方式 Emitting	正发光 Front light
适合板宽 Strip width	8mm
产品重量 Weight	75g/m
产品材质 Material	高品质耐黄变纯硅胶 Food-class silicone
尾端工艺 Tail end process	堵头打胶/液压堵头 Plug glue/hydraulic plug

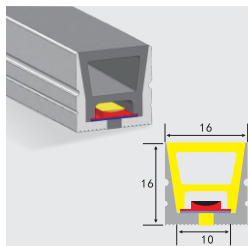

### 1616共挤(带防断)

出光方式 Emitting	正发光 Front light
适合板宽 Strip width	10mm
产品重量 Weight	210g/m
产品材质 Material	高品质耐黄变纯硅胶 Food-class silicone
尾端工艺 Tail end process	堵头打胶/液压堵头 Plug gluing/hydraulic plug

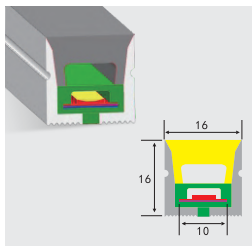

### 1616正发光三色共挤(带防断)

出光方式 Emitting	正发光 Front light
适合板宽 Strip width	10mm
产品重量 Weight	243g/m
产品材质 Material	高品质耐黄变纯硅胶 Food-class silicone
尾端工艺 Tail end process	堵头打胶/液压堵头 Plug gluing/hydraulic plug

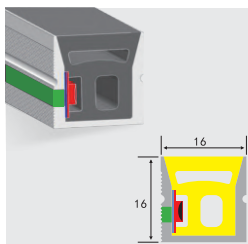

### 1616侧发光三色共挤(带防断)

出光方式 Emitting	正发光 Front light
适合板宽 Strip width	8mm
产品重量 Weight	240g/m
产品材质 Material	高品质耐黄变纯硅胶 Food-class silicone
尾端工艺 Tail end process	堵头打胶/液压堵头 Plug gluing/hydraulic plug

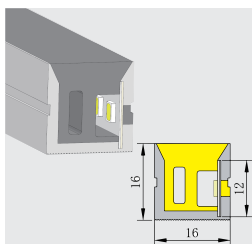

### 1616侧发光共挤(带防断)

出光方式 Emitting	正发光 Front light
适合板宽 Strip width	10mm
产品重量 Weight	243g/m
产品材质 Material	高品质耐黄变纯硅胶 Food-class silicone
尾端工艺 Tail end process	堵头打胶/液压堵头 Plug gluing/hydraulic plug

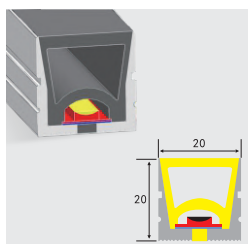

### 2020共挤(带防断)

出光方式 Emitting	正发光 Front light
适合板宽 Strip width	10mm
产品重量 Weight	368g/m
产品材质 Material	高品质耐黄变纯硅胶 Food-class silicone
尾端工艺 Tail end process	堵头打胶/液压堵头 Plug gluing/hydraulic plug

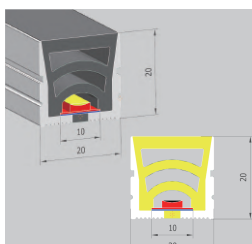

### 2020双层共挤(带防断)

出光方式 Emitting	正发光 Front light
适合板宽 Strip width	10mm
产品重量 Weight	243g/m
产品材质 Material	高品质耐黄变纯硅胶 Food-class silicone
尾端工艺 Tail end process	堵头打胶/液压堵头 Plug gluing/hydraulic plug

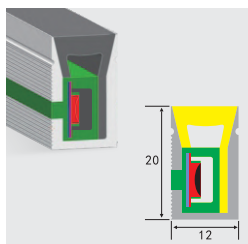

### 1220三色共挤(带防断)

出光方式 Emitting	正发光 Front light
适合板宽 Strip width	10mm
产品重量 Weight	224g/m
产品材质 Material	高品质耐黄变纯硅胶 Food-class silicone
尾端工艺 Tail end process	堵头打胶/液压堵头 Plug gluing/hydraulic plug



点亮效果

# 无边框液压堵头

Frameless Molding Caps

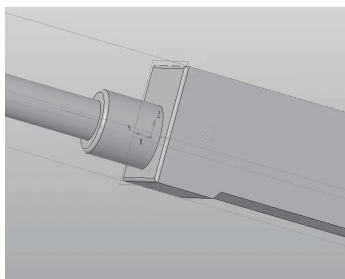
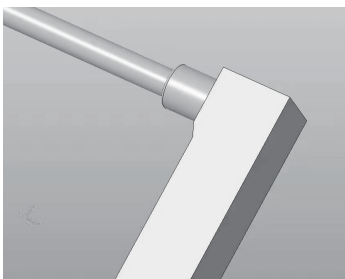
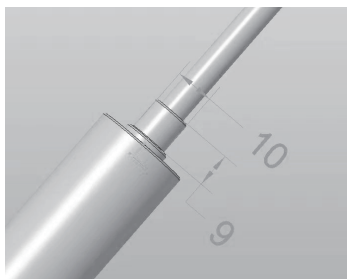
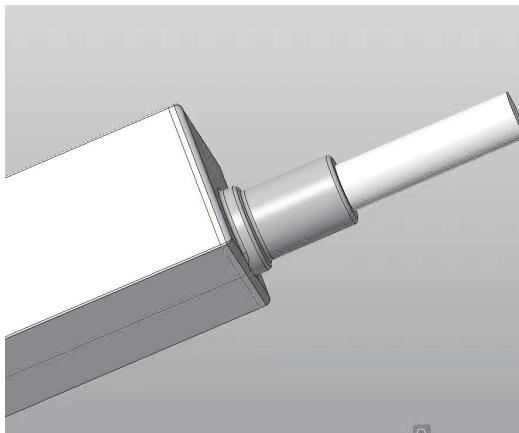
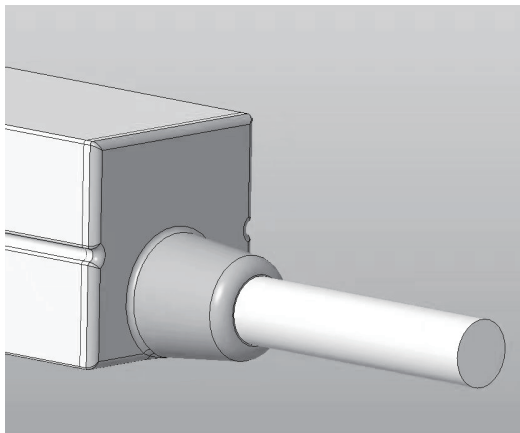

## 改性PVC套管系列 Modified PVC Tubes

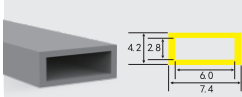

### 5宽PVC透明

出光方式 Emittance	透明/乳白 Transparent/lay white
适合板宽 Fit in width	5mm
产品重量 Weight	18g/m
产品材质 Material	高品质耐黄变树脂胶 High quality UV resistant
包装规格 Package	250米/卷 4米/箱 250m/roll 2roll/carton

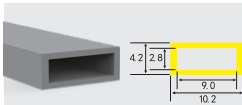
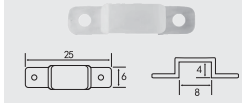

### 8宽PVC套管

出光方式 Emittance	透明/乳白 Transparent/lay white
适合板宽 Fit in width	8mm
产品重量 Weight	19g/m
产品材质 Material	高品质耐黄变树脂胶 High quality UV resistant
包装规格 Package	250米/卷 4米/箱 250m/roll 2roll/carton

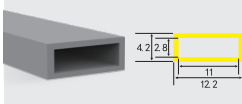
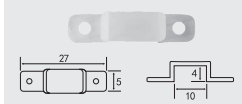

### 10宽PVC套管

出光方式 Emittance	透明/乳白 Transparent/lay white
适合板宽 Fit in width	10mm
产品重量 Weight	20g/m
产品材质 Material	高品质耐黄变树脂胶 High quality UV resistant
包装规格 Package	250米/卷 4米/箱 250m/roll 2roll/carton

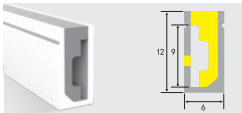
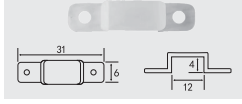

### 0612PVC霓虹套管

出光方式 Emittance	侧发光 Front Light
适合板宽 Fit in width	8mm
产品重量 Weight	94g/m
产品材质 Material	高品质耐黄变树脂胶 High quality UV resistant
包装规格 Package	100米/卷 2米/箱 100m/roll 2roll/carton

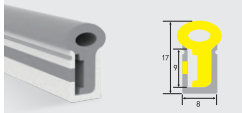
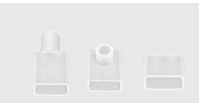
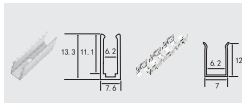

### 0817PVC霓虹套管

出光方式 Emittance	侧发光 Front Light
适合板宽 Fit in width	8mm
产品重量 Weight	145g/m
产品材质 Material	高品质耐黄变树脂胶 High quality UV resistant
包装规格 Package	100米/卷 2米/箱 100m/roll 2roll/carton

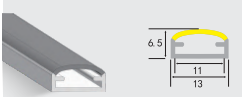
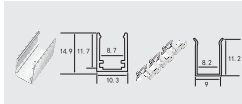

### 10宽PVC内卡双色

出光方式 Emittance	正白光 Front Light
适合板宽 Fit in width	10mm
产品重量 Weight	60g/m
产品材质 Material	高品质耐黄变树脂胶 High quality UV resistant
包装规格 Package	200米/卷 2米/箱 200m/roll 2roll/carton

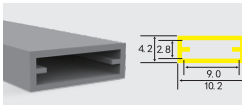
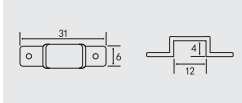

### 8宽带卡PVC套管

出光方式 Emittance	透明/乳白 Transparent/lay white
适合板宽 Fit in width	8mm
产品重量 Weight	30g/m
产品材质 Material	高品质耐黄变树脂胶 High quality UV resistant
包装规格 Package	250米/卷 4米/箱 250m/roll 2roll/carton

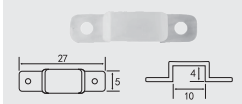

### 10宽带卡PVC套管

出光方式 Emittance	透明/乳白 Transparent/lay white
适合板宽 Fit in width	10mm
产品重量 Weight	32g/m
产品材质 Material	高品质耐黄变树脂胶 High quality UV resistant
包装规格 Package	250米/卷 4米/箱 250m/roll 2roll/carton

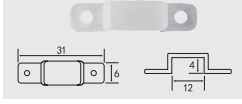

### 0613PVC霓虹套管

出光方式 Emittance	侧发光 Front Light
适合板宽 Fit in width	8mm
产品重量 Weight	94g/m
产品材质 Material	高品质耐黄变树脂胶 High quality UV resistant
包装规格 Package	100米/卷 2米/箱 100m/roll 2roll/carton

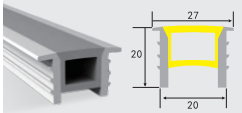
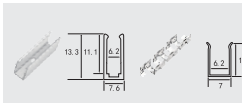

### 2020PVC无底带边

出光方式 Emittance	正白光 Front Light
适合板宽 Fit in width	20mm
产品重量 Weight	275g/m
产品材质 Material	高品质耐黄变树脂胶 High quality UV resistant
包装规格 Package	50米/卷 2米/箱 50m/roll 2roll/carton



点亮效果