

Model Number:
ST-24224245-2835

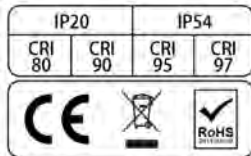

SunTech Lite is committed to provide high quality LED lighting product and superior service for market.

元硕达科技致力于提供高品质的LED产品，提供高品质的市场服务。

1. The LED are packaged with pure gold wires and large-size chips.
灯珠采用纯金线和大尺寸芯片封装。
2. Only one Bin LED is used for each order, and keep the same Bin LED in subsequent orders to ensure the consistency of the product.
每一个订单只使用一个BIN的灯珠，并且在后期订单也使用相同BIN，保证产品的一致。
3. The production process adopts high-temperature, lead-free SMT technology, the solder joints are smooth and full.
生产过程采用高温无铅SMT工艺，焊点圆滑饱满。
4. Use double-layer PCB to ensure stable electrical performance.
采用双面线路板，保证稳定的电气性能。
5. Use original authentic 3M tape, strong and long-lasting adhesion.
原装正品3M胶带，粘合力持久强劲。
6. A variety of installation accessories are optional, flexible and convenient to use.
多种安装配件可选，使用灵活方便。
7. Different IP grade are available: IP20, IP65, IP66, IP68.
防水等级可选: IP20, IP65, IP66, IP68。
8. High light transmittance, environment friendly silicone material is used for waterproof product, colorless, odorless and anti-yellowing.
防水材料用高透环保硅胶材料: 无色, 无味, 抗黄化。

Product description/产品描述

1. Dimensions/尺寸: 490*245mm
2. Power/功率: 28W/PCS
3. LED type灯珠型号:
Lumileds SMD2835, high brightness LED
4. LED quantity/灯珠数量: 242LEDs/PCS
5. LED color/灯珠颜色: white ,1800-20000K
6. Cut length/剪切长度:
DC24V 1LEDs/ 22.3*22.3mm
7. PCB material/PCB材质: double layer FPC
8. Life time/使用寿命: 36000hours
9. IP grade/防护等级: IP20

Application/应用

Home decoration lighting

家居装饰照明

Light box lighting stage lighting

灯箱照明舞台照明

Decoration of entertainment places

娱乐场所装修

Other auxiliary lighting

其他辅助照明

Product picture/产品图片



Application scenarios/应用场景



Technical parameters/性能参数

Optical parameters(white) 光学参数 (白光)	Electrical performance parameters 电气性能参数	Other parameters 其它参数
Luminous/光能量: 2800Lm/m CCT/相关色温: 1800-20000K CRI/显色指数: Ra>80 Beam angle/发光角度: 120° Light efficiency/光效: 100Lm/W	Voltage/额定电压: DC24V Current/额定电流: 1.16A Power/额定功率: 28W/m	Storage temperature/储存温度: -20~+60℃ Working temperature/工作温度: -20~+60℃ Life time/使用寿命: >36000 hours Warranty/质保时间: 3 years

Dimensions/尺寸



Color standard/颜色标准

<2200K

2700K

3000K

4000K

6000K

>8000K

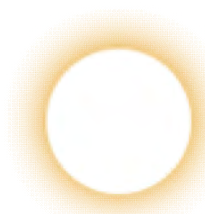

Super Warm White
White
烛光色



Warm White
高压钠灯

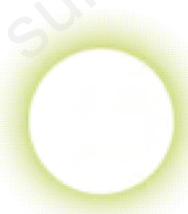

Warm White Halogen
Incandescent
白炽灯

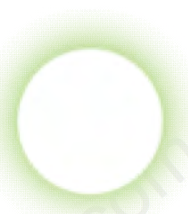

Natural White
Metal Halide
金卤灯



White
白色

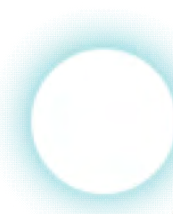

Cold White
冷白色

Connection diagram/连接图

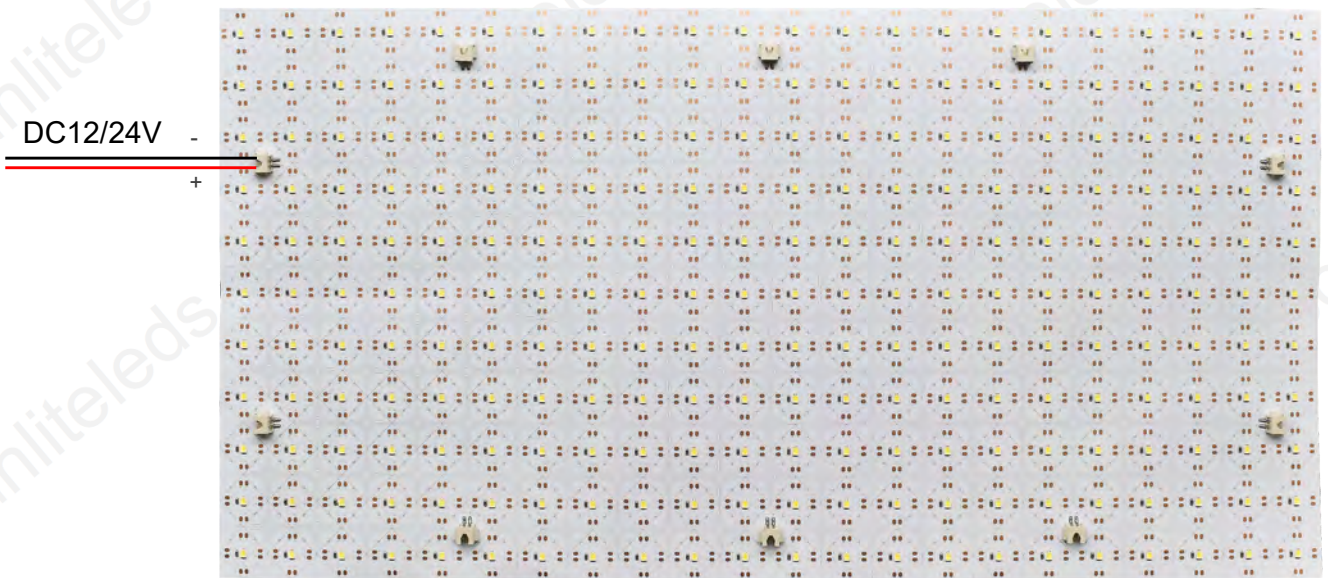

1. Connection method one/连接方式1

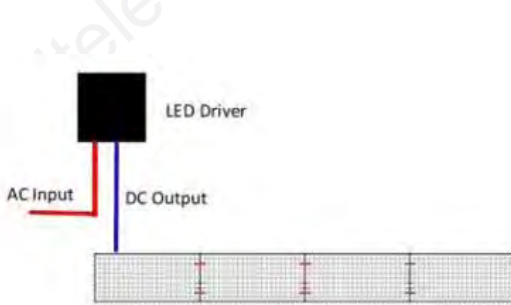

2. Connection method two/连接方式2

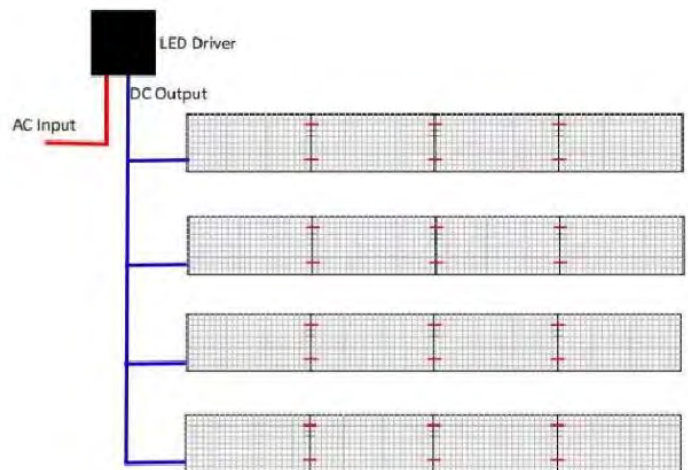

3. Connection method three/连接方式3

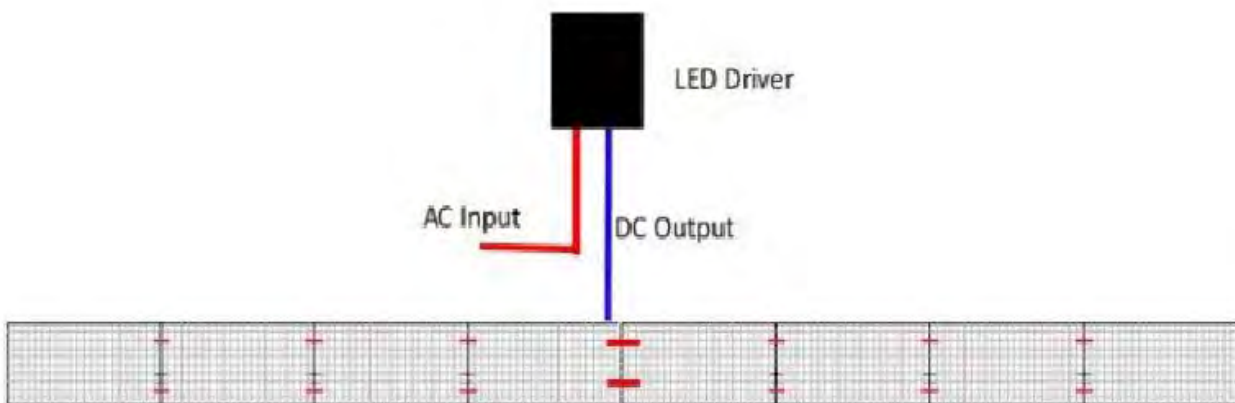

Connect/连接



1LED Cut,With Connector, Free Cutting and Splicing, Easy to DIY Styling.

单灯可剪，带接线端子，随意裁剪，任意拼接，方便DIY造型。

Ultra Wide 245mm PCB, No Voltage Drop,Uniform Brightness the Whole Board, Big size easy to Application, No complex connection.

245mm超宽PCB，无压降，整板亮度均匀大尺寸应用简单，无需繁琐接线。

Free Cutting/随意剪切

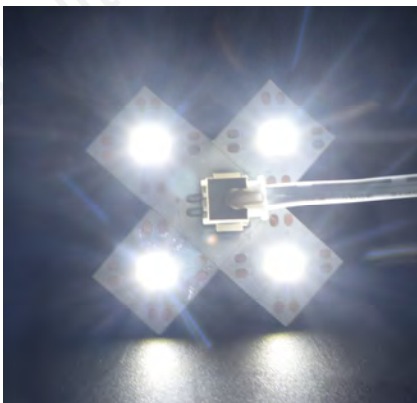

Accessories/配件



Connection piece*2

连接件*2



Connecting line*2

连接线*2



Anti-collision silicone particles*8

防撞硅胶粒*8

Packing instruction/包装

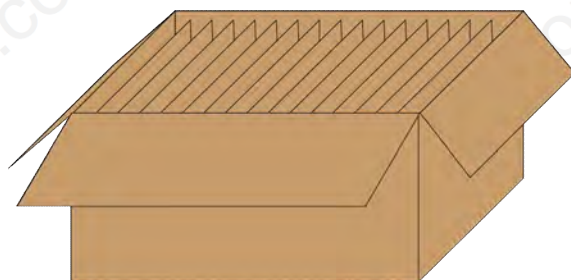

Notes/说明

The regular packing is 5m/roll, special length need to be customized.

常规包装为5米/卷，特殊长度需要定制。

Do not place heavy products on the top of the cartons, do not step on it.

不要把沉重的产品放在纸箱顶部，不要踩在上面。

After receiving the package, if the outer box was damaged, please check the goods before signing for receipt.

收到包裹后，如果外箱损坏，请在签收前对货物进行检查。